

DOGHER

Making Solutions [®] TOOLS



PROMOTION

20²³₂₄

**INDUSTRIAL QUALITY
MAXIMUM PERFORMANCE**



RECOMMENDED RETAIL PRICES
EXCLUDING VAT

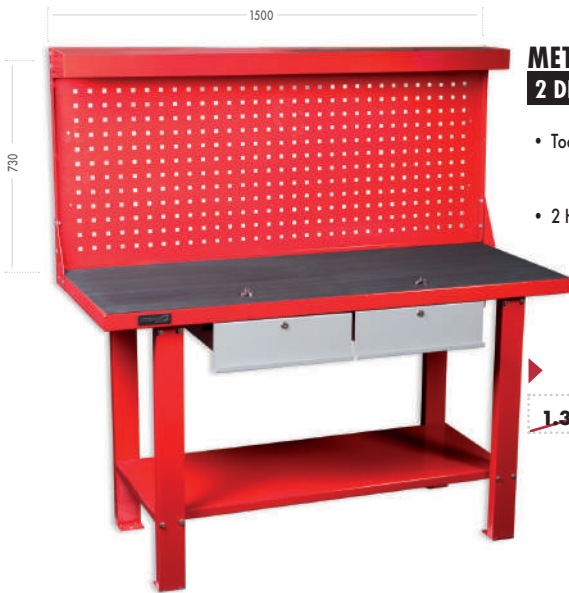

METAL WORK BENCH WITH TOOL-KEEPER BOARD

2 DRAWERS

- Tool-Keeper Board
- 2 High Capacity Drawers

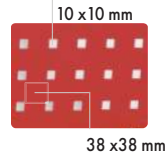

Max. Load: **900 kg**
 Bench: **1500 x 640 x 1550 mm**
 Tool-keeper Board: **1500 x 730 mm**

Ref 027-004

~~1.327,47 €~~ **761,34 €**

METAL WORK BENCH

3 DRAWERS

- 3 High Capacity Drawers

Max. Load: **500 kg**
 Bench: **2000 x 640 x 865 mm**



Ref 027-001

~~1.280,58 €~~ **753,28 €**

CYLINDRICAL BENCH VICE

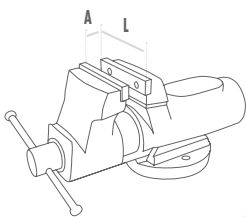

L mm	A mm	Kg	Ref		
▶ 100	105	13	925-100	339,42 €	199,68 €
125	130	22	925-125	467,36 €	274,91 €
150	165	32	925-150	667,33 €	392,54 € ▶

• Swivel base see page 493 of the 2023 DOGHER Catalogue

SQUARE GUIDED BENCH VICE

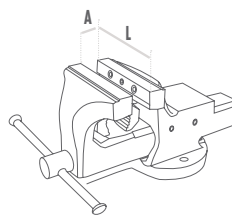

L mm	A mm	Kg	Ref		
▶ 100	105	7,5	926-100	226,98 €	133,51 €
125	155	14	926-125	252,93 €	148,79 €
150	165	19	926-150	365,18 €	214,82 €
175	205	26	926-175	578,33 €	340,19 € ▶

• Swivel base see page 493 of the 2023 DOGHER Catalogue



MAXIMUM PERFORMANCE

- 3 removable modules
- 1 tool box
- 2 high capacity drawers
- 1 folding chest

**SOLUTIONS
3 IN 1**

Ref 051-002

~~319,95 €~~ **188,21 €**

490 x 300 x 720 mm

INTERMODULE COUPLINGS

Stronger,
avoids uncomfortable oscillations



SAFETY LOCKS

Double Metal Safety Lock



PADLOCK CLOSING POSSIBILITY



3 FLOOR TROLLEY

+47 TOOLS



300 mm
720 mm
490 mm

**27
Pcs**

1/2"



(531-080)



8 • 9 • 10 • 11 • 12 • 13 • 14 • 15 • 16 • 17
18 • 19 • 20 • 21 • 22 • 23 • 24 • 27 • 30 • 32



250 mm
125 mm



• 3/8" • 1/2" (524-021)



16 • 21

Ref 051-500

~~874,77 €~~ **501,71 €**

**10
Pcs**



(450-081)



6x7 • 8x9 • 10x11 • 12x13 • 14x15
16x17 • 18x19 • 20x22 • 21x23 • 24x26

**10
Pcs**



(330-084)



4 • 5,5 • 6,5



PH1 • PH2



4 • 5,5 • 6,5



PH1 • PH2

METAL TROLLEY

COMPACT

- 1 Tool box with portable tray inside
- 2 drawers
- 1 High capacity folding chest
- Removable telescopic rear handle



265 mm
550 mm
410 mm

SAFETY LOCKS
Double Metal Safety Lock

Ref 051-008

~~192,49 €~~ **99,07 €**

METAL TROLLEY

COMPACT

- 1 Tool box with portable tray inside
- 4 drawers (2 High capacity drawers)
- Removable telescopic rear handle



265 mm
550 mm
410 mm

SAFETY LOCKS
Double Metal Safety Lock

Ref 051-009

~~202,79 €~~ **119,28 €**



TROLLEY**3 MODULES**

- 1 Folding Chest
- 1 Tool Box
- 3 High Capacity Drawers
- High Resistance Plastic Wheels



Ref 051-004

~~181,85 €~~ **106,97 €** 505 x 330 x 835 mm

TROLLEY**2 MODULES**

- 1 Tool Box
- Round Organizer
- 1 High Capacity Chest
- Frontal Nylon Bag



Ref 051-005

~~113,29 €~~ **66,65 €** 485 x 310 x 635 mm

SOLID HANDLE ORGANIZER

- Removable Organizing Cases

Ref 052-006
~~16,44 €~~ **7,25 €**

210 x 338 x 62 mm

**HIGH CAPACITY MOBILE HANDLE ORGANIZER**

- Removable Organizing Cases

Ref 052-010
~~21,53 €~~ **9,50 €**

340 x 250 x 60 mm

**TOOL BOX****1 TRAY + 3 ORGANIZERS**

- Double Metal Safety Lock
- Portable Tray Inside

Ref 050-010
~~47,20 €~~ **27,07 €**



490 x 262 x 250 mm

**ROLLING TOOL BOX**

3 Accessory Organizers

Ref 051-006
~~148,80 €~~ **87,53 €**

620 x 370 x 420 mm

**GALVANIZED SHEET CHESTS WITH METAL SAFETY LOCK**

L mm	Maximum Load	Ref	Price	Price
555 x 230 x 210	40 kg	028-002	159,90 €	94,06 €
759 x 327 x 250	50 kg	028-003*	270,75 €	159,26 €
1.144 x 367 x 380	50 kg	028-004*	334,77 €	196,91 €
1.429 x 502 x 476	60 kg	028-005*	582,95 €	342,91 €

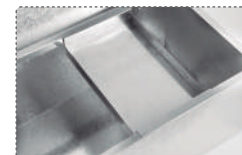

* Tray Included





**TOOL BOX
+50 INDUSTRIAL QUALITY TOOLS**

- Professional Metal Tool Box Ref:026-001
- 5 High Capacity Trays
- Maximum Total Load 30Kg



PROFESSIONAL COMPOSITION

Includes Tool Box and 50 Tools



495 x 200 x 230 mm

Ref 026-500
~~748,56 €~~ **432,12 €**



**TOOL BOX
5 TRAYS**

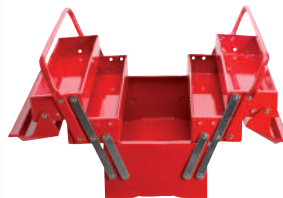

Ref 026-001
~~97,36 €~~ **57,25 €**

495 x 200 x 230 mm

**TOOL BOX
3 TRAYS**



Ref 026-002
~~76,90 €~~ **45,24 €**

495 x 200 x 180 mm



**TOOL BOX
5 TRAYS LONG SERIES**



Ref 026-005
~~108,78 €~~ **63,99 €**

550 x 200 x 208 mm



**PROFESSIONAL
METAL TOOL BOX**

- 1 Tray
- 2 Drawers
- Double Metal Safety Lock
- 30 kg Max. Total Load

Ref 026-003
~~131,75 €~~ **58,12 €**

510 x 218 x 250 mm

**TOOL BOX
1 TRAY + 6 DRAWERS**

- Top Tray
- Side Handle
- Safety Lock with Key

Ref 028-001
~~520,77 €~~ **306,34 €**

668 x 316 x 386 mm



• 5 kg Max. Load per Drawer

GOBOX

by DOGHER TOOLS

WATERPROOF TROLLEY

- Waterproof and airtight (IP 67)
- Interstackable
- Corrosionproof, sandproof and dustproof
- Shockproof and crushproof
- Temperature rating -33°C/+90°C
- Ergonomic handle, rubber coated grip
- Anti-stuck latches with user-friendly opening mechanism
- Corrosion proof metal hinges with lid stay features
- Automatic pressure release valve
- Sealing O-ring
- External sizes: 568x467x274mm / Internal sizes: 546x392x233mm
- Lid depth: 54 mm / Base depth: 179 mm



Ref 051-010



Ref 051-010

~~742,26 €~~ **436,62 €**

568 x 467 x 274 mm

TROLLEY INDUSTRIAL TOOLS

▶ Ref 051-510
~~2.564,60 €~~ **1.470,88 €**

• See composition in page 41 of the 2023 DOGHER Catalogue



139
Pcs



TROLLEY ELECTRICIANS TOOLS

139
Pcs

▶ Ref 051-511
~~2.812,85 €~~ **1.613,26 €**

• See composition in page 42 of the 2023 DOGHER Catalogue



+



TROLLEY ELECTRICIANS TOOLS

▶ Ref 051-512
~~2.558,80 €~~ **1.505,19 €**

• See composition in page 43 of the 2023 DOGHER Catalogue

67
Pcs

5331-001



ANTI-CORROSION

HIGH AND LOW
TEMPERATURES RESISTANCESHOCK
RESISTANT

NEW



HIGH DENSITY POLYPROPYLENE CHEST WITH WHEELS



▶ Ref 028-020
~~321,73 €~~ **188,31 €**

780 x 410 x 330 mm



- High resistance trunk
- Light weight and high load capacity
- Suitable for outdoor use
- Front handle
- High resistance wheels
- Closure option with locks.
- Stackable
- Ideal for construction / maintenance / transport



ANTI
CORROSION



HIGH AND LOW
TEMPERATURES RESISTANCE



SHOCK
RESISTANT

D-BOX
by DOGHER TOOLS

**GREAT CAPACITY PROFESSIONAL
COMPACT SUITCASE**

NEW

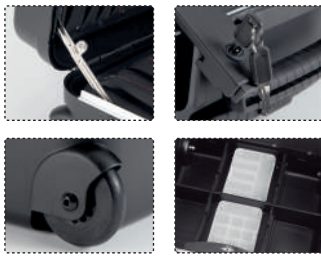

- Injected Moulded Polypropylene
- Extremely light
- Ergonomic handle for easy carrying
- High resistance wheels
- Side locks with keys
- Robust metal bearers to fasten tool holders
- Superior strip for documents
- 2 organizers included
- Removable tool holders



Ref 051-015

~~449,45 €~~ **263,06 €**

430 x 320 x 190 mm

GREAT CAPACITY PROFESSIONAL

+ 69 INDUSTRIAL QUALITY TOOLS

NEW



69
Pcs



Ref 051-515

~~1.019,03 €~~ **596,43 €**



ANTI
CORROSION



HIGH AND LOW
TEMPERATURES RESISTANCE



SHOCK
RESISTANT

TEKBOX
by DOGHER TOOLS

**HIGH DENSITY
PROFESSIONAL SUITCASE**

NEW



- Injected Moulded Polypropylene
- Ergonomic handle for easy carrying
- High resistance wheels
- 2 keys double locks
- Identifying external label
- Removable tool holders
- Low compartment with adjustable and removable dividers
- High resistance metallic hinges



Ref 051-016

~~567,79 €~~ **332,32 €**

465 x 352 x 255 mm

HIGH DENSITY PROFESSIONAL SUITCASE

+ 94 INDUSTRIAL QUALITY TOOLS

NEW



94
Pcs



Ref 051-516

~~1.543,72 €~~ **903,53 €**

ALUBOX

by DOGHER TOOLS

Aluminium Suitcase + 85 Industrial Quality Tools



Ref 051-020

~~111,16 €~~ **65,37 €**

Light and very resistant Aluminium Suitcase with metallic protections at the corners.
Double locking key and bi-material handle.

4 standing bases at the bottom face in order to place the suitcase in any kind of surface without damaging it.

Two trays inside the suitcase, a mobile one and a fixed one on top side to store tools.

The mobile tray is joined with the suitcase by means of 3 strong hinges; it can also be adjusted to two positions through a belt fixed to the top side.



ALUMINIUM SUITCASE + 85 INDUSTRIAL QUALITY TOOLS

1/2"



85

Pcs



EXTERNAL 465 x 375 x 165 mm
INTERNAL 445 x 337 x 96 mm

Ref 051-520

~~839,28 €~~ **493,71 €**

RUCKSACK WITH WHEELS



- Maximum Performance:
- Specific Compartments for each tool.
- Large Storage Capacity
- Zipper Opening for Easy Access Inside
- Reinforced Ergonomic Handle
- Telescopic Arm
- Adjustable Bets

Ref 076-014

~~166,75 €~~ **98,09 €**

360 x 275 x 500/1050 mm



Ref 076-520

~~545,89 €~~ **321,10 €**

• See composition in page 60 of
the 2023 DOGHER Catalogue



Ref 076-521

~~520,78 €~~ **306,34 €**

• See composition in page 60 of
the 2023 DOGHER Catalogue

PROFESSIONAL RUCKSACK

- Specific compartments for every kind of tools
- High Storage Capacity
- Zipper opening for easy access inside
- Specific pocket for organizer 052-014
- Reinforced Ergonomic Carrying Handle
- Adjustable Belts



- 410 x 295 x 240 mm
- 20 kg Max Load

Ref 076-004

~~79,70 €~~ **46,88 €**

* Tools not included

PROFESSIONAL RUCKSACK + 1 ORGANIZER + 32 TOOLS



410 x 295 x 240 mm

Ref 076-501

~~433,73 €~~ **255,15 €**

• See composition in page 59 of the 2023 DOGHER Catalogue

Ref 076-500

~~458,84 €~~ **269,91 €**

• See composition in page 59 of the 2023 DOGHER Catalogue

NYLON UNIVERSAL OPEN TOOL BOX

- Reinforced handling bar
- High storage capacity
- Water resistant inner lining
- Specific pockets for tools
- Handle and Shoulder Strap for comfortable carrying



410 x 215 x 335 mm

Ref 076-002

~~76,71 €~~ **45,12 €**

* Tools not included

TOOL BAG GATE MOUTH 20"

- Rigid opening for an easy use
- High storage capacity
- Water resistant inner lining



520 x 250 x 290 mm

Ref 076-012

~~78,95 €~~ **46,44 €**

* Tools not included

TOOL WRAP WITH HANDLE

- Reinforced ergonomic carrying handle
- 18 Versatile compartments
- Adjustable belts



350 x 85 x 195 mm

Ref 076-003

~~49,81 €~~ **29,29 €**

* Tools not included

UNIVERSAL TOTE

- High Storage Capacity, indispensable for the professional
- Shoulder Strap for Comfortable carrying
- Specific pockets for tools both inside and outside



290 x 185 x 220 mm

Ref 076-006

~~55,56 €~~ **32,68 €**

* Tools not included

RECHARGEABLE LED WORK LIGHT



Model	Vega	Altair	Polux	Adhara	Compact	Stylo	Rigel	Shaula	Testa
Reference	1000-001	1000-002	1000-003	1000-004	1000-009	1000-015	1000-020	1000-021	1000-030
Luminous Flux	700 lumens	400 lumens	450 lumens	UV 395nm	300 lumens	150 lumens	600 lumens	280 lumens	400 lumens
CRI	80	80	80	80	80	80	80	80/70	80
CCT	6500K	6500K	6500K	6500K	6500K	6500K	6500K	6000K/6500K	6500K
Protection Grade	IP65/IK07	IP54/IK07	IP54/IK07	IP54/IK07	IP54/IK07	IP20/IK07	IP44/IK07	IP44/IK07	IP65/IK07
Lighting Levels	3	1	2	2	2	1	2	5	2
Runtime	4h	5h	5h	4h 30'	2h 30'	3h	3h 30'	1h 30'	4h
Batterie 3.7 V	2600 mAh Li-ion	2600 mAh Li-ion	2600 mAh Li-ion	2600 mAh Li-ion	1500 mAh LiPo	800 mAh Li-ion	2600 mAh Li-ion	750 mAh Li-ion	1500 mAh Li-ion
Charging Time	3h 30'	3h 30'	3h 30'	3h 30'	2h 30'	1h 30'	3h 30'	2h	2h 30'
Top Light	150 lumens	120 lumens	100 lumens	100 lumens	NO	80 lumens	100 lumens	150 lumens	NO
	Base & Back	Base & Back	Base & Back	Base & Back	Base	Clip	Base	Base	NO
Pivot Joint	180°	180°	180°	180°	Rotating Base 360°	NO	180°	180°	4 Positions

RECHARGEABLE WORK LIGHT 700 LUMENS COB LED

VEGA

Ref 1000-001

~~91,50 €~~ **53,56 €**

268 x 61 x 42 mm

RECHARGEABLE WORK LIGHT 400 LUMENS COB LED

ALTAIR

Ref 1000-002

~~90,35 €~~ **52,88 €**

268 x 61 x 42 mm

RECHARGEABLE WORK LIGHT 450 LUMENS COB LED

POLUX

Ref 1000-003

~~89,10 €~~ **52,15 €**

199 x 51 x 36 mm

RECHARGEABLE UV WORK LIGHT 395nm WAVELENGTH COB LED

ADHARA

Ref 1000-004

~~92,25 €~~ **54,00 €**

199 x 51 x 36 mm

RECHARGEABLE WORK LIGHT 300 LUMENS COB LED

COMPACT

Ref 1000-009

~~96,21 €~~ **56,31 €**

127 x 69 x 33 mm

RECHARGEABLE WORK LIGHT 150 LUMENS COB LED

STYLO

Ref 1000-015

~~78,36 €~~ **45,87 €**

167 x 25 x 33 mm

RECHARGEABLE WORK LIGHT

600 LUMENS COB LED

RIGEL



Ref 1000-020

~~96,36 €~~ **56,40 €**

397 x 66,5 x 46 mm

RECHARGEABLE WORK LIGHT

280 LUMENS COB LED

SHAULA



Ref 1000-021

~~73,10 €~~ **42,78 €**

307 x 30 x 17 mm

LED HEADLAMP

400 LUMENS COB LED

TESTA



Ref 1000-030

~~56,36 €~~ **32,99 €**

47,5 x 78,5 x 42 mm

- High-quality, adjustable, non-slip, ergonomic headband.

- 4 Position Angles.

- Contactless ON/OFF movement sensor.

GREASE

PUMP

FLEXIBLE HOSE

GREASE PUMP

8.000
PSI

1/8 BSP



915-030



- Air Release Valve
- Bulk Charge

Bulk cc	Container gr	L Pump	Ø Pump	L Hose	Ø Hose	Ref	
500	400	350	57,5	300	8,5	915-030	38,18 € 22,46 €

PROGRESSIVE

BLOW GUN

Ø mm
8

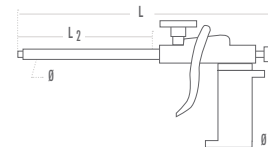

L mm	L2 mm	Ø mm	Ø2 mm	Ref	
210	100	8	1/4" G (BSP)	914-010	19,32 € 11,37 €

- Maximum air pressure: 12 Bar · 175 PSI · 1,2 Mpa
- Nozzle with metal reinforcement.
- Body manufactured in High performance POM



L mm	L2 mm	Ø mm	Ø2 mm	Ref	
306	202	8	1/4" G (BSP)	914-015	22,66 € 13,32 €

- Maximum air pressure: 12 Bar · 175 PSI · 1,2 Mpa
- Nozzle with metal reinforcement.
- Body manufactured in High performance POM

MULTI CIRCLIPS®

PLIER



Knot position for internal Seeger circlip handling



Knot position for external Seeger circlip handling



Interchangeable bent tips



Interchangeable straight tips



Storage for spare tips

6 IN 1



▶ 200 mm Ref 220-001
~~47,73 €~~ 28,07 €

- Internal / external Straight and Bent Tips
- Includes 3 pairs of spare tips:
 1 pair of straight tips + 2 pairs of Bent Tips

CIRCLIP®

PLIERS PRO

- Reinforced tips.
- Higher resistance and durability

STRAIGHT TIPS EXTERNAL CIRCLIP® PLIER PRO



L mm	∅ Min mm.	∅ Max mm.	Ref	Price	Price
▶ 140	3	10	220X-140	27,90 €	16,21 €
140	10	25	220X-155	24,92 €	14,49 €
180	19	60	220X-180	29,10 €	16,90 €
240	40	100	220X-220	33,64 €	19,54 €
330	85	140	220X-300	55,57 €	32,28 € ▶

BENT TIPS EXTERNAL CIRCLIP® PLIER PRO



L mm	∅ Min mm.	∅ Max mm.	Ref	Price	Price
▶ 130	3	10	221X-140	27,90 €	16,21 €
130	10	25	221X-155	25,40 €	14,75 €
170	19	60	221X-180	28,69 €	16,66 €
220	40	100	221X-220	34,26 €	19,91 €
315	85	140	221X-300	55,57 €	32,28 € ▶

STRAIGHT TIPS INTERNAL CIRCLIP® PLIER PRO



L mm	∅ Min mm.	∅ Max mm.	Ref	Price	Price
▶ 140	8	13	222X-140	27,90 €	16,21 €
140	12	25	222X-155	25,40 €	14,75 €
180	19	60	222X-180	29,10 €	16,90 €
230	40	100	222X-220	33,64 €	19,54 €
320	85	140	222X-300	55,57 €	32,28 € ▶

BENT TIPS INTERNAL CIRCLIP® PLIER PRO



L mm	∅ Min mm.	∅ Max mm.	Ref	Price	Price
▶ 125	8	13	223X-140	27,90 €	16,21 €
125	12	25	223X-155	25,40 €	14,75 €
170	19	60	223X-180	29,10 €	16,90 €
220	40	100	223X-220	34,57 €	20,07 €
300	85	140	223X-300	55,57 €	32,28 € ▶

SET ZIPPING

4 CIRCLIP® PLIERS PRO



L mm	∅ Min mm.	∅ Max mm.	Ref	Price	Price
▶ 155	12	25	220X-004	110,37 €	64,10 €
180	19	60	220X-002	125,24 €	72,74 € ▶



290 x 215 mm

**PROFESSIONAL ALUMINIUM
PIPE WRENCH**

- 60HRc jaw hardness
- 38% more opening than forged pipe wrench
- Aluminium body, 40% lighter
- Monoblock body, higher strengthness



CrV



L"	L mm	Ø max.	Ref	Price	Price
▶ 10	250	Ø49	655-250	49,89 €	28,62 €
14	350	Ø60	655-350	66,48 €	38,13 €
18	450	Ø76	655-450	95,05 €	54,51 €
24	600	Ø90	655-600	140,89 €	80,81 €
36	900	Ø140	655-900	280,81 €	161,04 €
48	1210	Ø168	655-1210	453,85 €	260,29 € ▶

**PROFESSIONAL SPANISH TYPE
PIPE WRENCH**

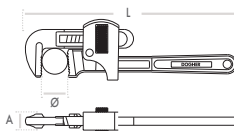

60HRc

CrV



L"	L mm	Ø max.	Ref	Price	Price
▶ 8	200	Ø25	650-200	27,21 €	15,60 €
10	250	Ø35	650-250	36,08 €	20,69 €
12	300	Ø44	650-300	41,52 €	23,81 €
14	350	Ø50	650-350	45,88 €	26,31 €
18	450	Ø60	650-450	62,02 €	35,56 €
24	600	Ø76	650-600	100,92 €	57,87 €
36	900	Ø102	650-900	207,54 €	119,03 € ▶

**PROFESSIONAL CHAIN
PIPE WRENCH**

CrV



L"	L mm	Ø mm	Ref	Price	Price
▶ 12	300	90	662-001	53,42 €	31,43 € ▶

**MULTIPURPOSE
TUBE BENDER**



NEW
▶ Ref 662-020
~~42,36 €~~ 24,79 €

- For 6-8-10 mm Tubes



**PVC PIPE CUTTER
AUTOMATIC RETURN**



Position 1 **Ø27 mm**
Position 2 **Ø45 mm**



▶ 0-45 mm Ref 665-45
~~73,48 €~~ 43,22 €

- To cut polyethylene, Ppr, multilayer....
- Cutting capacity selection pin (27 a 45 mm)
- Forged and tempered Steel Blade.

**ZIP ACTION
TUBE CUTTER**

- Cu
- Al
- Inox



▶ 3-32 mm Ref 675-03-32
~~26,33 €~~ 15,10 €

Includes Deburring Tool

UNIVERSAL CONTROL CABINET KEY

WATER, GAS

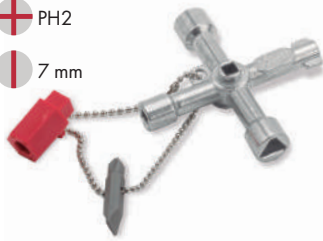
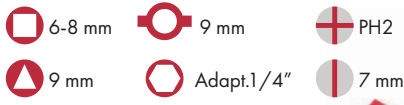

Ref 470-001

~~23,37 €~~ **13,74 €**

UNIVERSAL CONTROL CABINET KEY

HEAT, AC

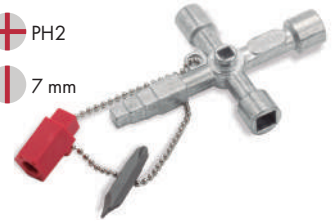

Ref 470-002

~~23,79 €~~ **13,99 €**

BUTTON QUICK RELEASE

WATER PUMP PLIER

- Longer and thinner jaws: Better accessibility
- Chrome vanadium forged steel body
- PVC anti-slip handle
- Anti-rust black finished
- Hardened jaws higher resistance and durability
- 4 teeth locking button
- 35% more opening

CrV



L mm	Ø max. mm	Ref		
▶ 150	26	269-150	40,46 €	23,68 €
180	38	269-180	43,25 €	24,81 €
240	50	269-240	46,14 €	26,46 €
300	70	269-300	57,29 €	32,87 €
400	90	269-400	100,93 €	57,88 € ▶

STANDARD BUTTON FUNCTION

WATER PUMP PLIER

CrV



L mm	Ø max. mm	Ref			
▶ 150	26	2690-150	26,36 €	15,43 €	NEW
180	38	2690-180	30,25 €	17,71 €	NEW
250	50	2690-250	33,14 €	19,01 €	
300	70	2690-300	46,75 €	26,81 €	▶

TWIN SLIP-JOINT

WATER PUMP PLIER

CrV



L mm	Ø mm	Ref		
▶ 250	37	268-250	23,82 €	14,01 € ▶

ANTI-SLIP HANDLE TWIN SLIP-JOINT

WATER PUMP PLIER

CrV

L mm	Ø mm	Ref		
▶ 250	48	267-250	31,97 €	18,79 € ▶

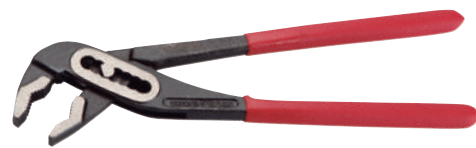

WIRE TIE TENSIONING

TOOL

CrV

L mm	Max mm	Ref		
▶ 190	12 x 2,3	268-010	58,63 €	34,31 € ▶



ZIPPER POUCH SET

3 PLIERS TOP Plier

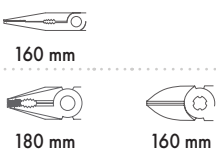

Ref 210-002

~~72,81 €~~ **42,82 €**



SELF ADJUSTING

LOCKING PLIER WITH WIRE CUTTER



- Pressure adjustment by internal mechanism.
- Non-slip knurled handles.
- Treated jaws for longer working life.
- AUTOMATIC Patented locking plier.

AUTOMATIC



CrMo

L mm	L "	Ref
150	6	275-005
250	10	275-010

AUTOMATIC

46,20 €	27,04 €	NEW
50,38 €	29,63 €	

SELF ADJUSTING STRAIGHT JAWS PLIER

WITHOUT WIRE CUTTER



CrMo

L mm	L "	Ø mm	Ref
250	10	48	277-010

AUTOMATIC

54,45 €	31,87 €
--------------------	----------------

NEW

CURVED JAWS LOCKING PLIER

WITHOUT WIRE CUTTER



100%
More grip power

- Curved Jaws
- Large opening jaws indicated for round shapes. Used in workshops, plumbing, heaters...
- A great capacity curved and fine jaws: Firm grip on rounded forms

L mm	L "	Ref	Price	Price
175	7	275-175	27,50 €	16,18 €
250	10	275-250	31,24 €	18,37 €



CURVED JAWS PLIER

WITH WIRE CUTTER



L mm	L "	Ref	Price	Price
175	7	276-175	26,63 €	15,66 €
250	10	276-250	29,03 €	17,07 €

CURVED JAWS

LOCKING PLIER



L mm	Ø mm	P mm	Ref	Price	Price
250	85	73	275F-011	72,51 €	42,66 €

AUTOMATIC

HAND VICE



CrV

L mm	L "	B mm	A mm	Ref
200	8	70	30	275-050

AUTOMATIC

75,14 €	43,99 €
--------------------	----------------

NEW

SWIVEL ANVIL

MITRE CUTTER

49,08 €	28,87 €	Ref 285-45-135	SK5	45°	135°
--------------------	----------------	----------------	-----	-----	------

- Hardened steel and non-slip handle.
- Used to cut rubber, profiles, electric gutters till maximum 40 mm wide and 25 mm long.
- Both straight and curve cuts 45° - 135°



CUT-PRO SCISSORS

- Anti-slip serrated edge.
- Bimaterial handle.

Inox



CUT PRO

MULTI-FUNCTION SCISSORS

NEW

< 0.8 mm < 1.2 mm < 0.5 mm < 0.4 mm < 4.0 mm < 5.0 mm < Ø10 mm



Inox

▶ 206 mm Ref 296-011
~~25,23 €~~ 14,76 €

CUT-PRO ELECTRICIAN SCISSORS



- Wire cutting notch. 1,5mm² / 2,5mm² / 4 mm².
- Max. cutting capacity: 1x80 mm²
- Special Solid stainless steel frame
- Crimping function included 2,5mm²

▶ 170 mm Ref 296-010
~~47,67 €~~ 28,04 €

CUT-PRO ELECTRICIAN SCISSORS XXL



Inox



- Max. cutting capacity: 1x50 mm²
- Integral steel body
- Crimping function included.
- Wire cutting notch: 1,5mm² / 2,5mm².

▶ 160 mm Ref 296-009
~~35,78 €~~ 21,04 €

CUT-PRO ELECTRICIAN SCISSORS



Inox



▶ 150 mm Ref 296-008
~~23,16 €~~ 13,62 €

HEAVY DUTY LARGE ELECTRICIAN SCISSORS GRIP XXL



Inox



- Serrated Blade
- Bi-material handle
- Maximum cutting capacity 1 x 50 mm²

▶ 150 mm Ref 296-004
~~27,38 €~~ 15,90 €

PROFESSIONAL ELECTRICIAN SCISSORS

- Serrated Blade
- Inner layer with soft rubber

Inox



▶ Ref Scissor+Holster 296-007
~~26,81 €~~ 15,40 €

▶ 145 mm Ref 296-006
~~22,69 €~~ 13,34 €

CABLE & WIRE STRIPPER



• Ø 4 - 28 mm 5/32" - 1 1/8" • Ø 0,5 - 6 mm² 20 - 10 AWG



▶ Ref 296-132
~~38,22 €~~ 22,47 €

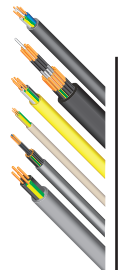

SELF-ADJUSTING AUTOMATIC WIRE STRIPPING



• Ø 0,2-6 mm² 24-10 AWG



▶ Ref 296-152
~~48,45 €~~ 28,50 €

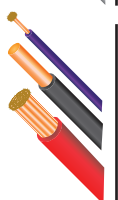

CRIMPING TOOL SET



- High wear resistance processed steel.
- Quick jaws change mechanism.
- Lock/unlock system.
- Ergonomic bi-material handle.



Ref 296-064

~~182,37 €~~ 106,74 €

SOLAR CONNECTOR RATCHET CRIMPING TOOL



- High resistance tempered forged steel jaw.
- Bi material handle.
- 2,5 - 4 - 6 mm²
- AWG 14 - 12 - 10

PATENTED

Ref 296-066

~~130,37 €~~ 76,31 €

SELF-ADJUSTING CRIMPING RATCHET PLIER FOR WIRE END SLEEVES WITH LATERAL ACCESS

0,25-16 mm²

Ref 296-061

~~96,67 €~~ 56,87 €

- High crimping capability due to solid square shaped lock (Self-releasing mechanism). Strong metal crimping profile with hardened surface.
- For cord end sleeves: 0,25 ~ 16mm².
- Reinforced connecting spring for a longer working life.
- Bimaterial handle for ergonomic and intensive use.
- Side loading on the cord end sleeve into the tool.
- Phosphated body to avoid corrosion.



EXPERT RATCHET CRIMPING TOOL



- Insulated terminal crimping range 1.5-2,5-6 mm²
- Hardened & tempered steel
- Ratchet mechanism controlled, accurate crimping
- Force amplifying ratchet mechanism
- Handle locking function
- Ergonomic handle

~~220 mm~~ Ref 296-060

~~37,85 €~~ 22,26 €

NET CRIMPING TOOL



Ref 296-062

~~84,60 €~~ 49,76 €

- Suitable for crimping RJ45 & RJ11 modular plugs with 6 or 8 connectors.
- Stripping blade working range is 6-12mm length.
- Reinforced connecting spring for a longer working life.
- Bimaterial handle for ergonomic and intensive use.
- Phosphated body to avoid corrosion.

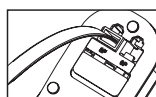

- Squeeze handle to activate crimping action.

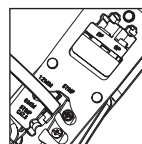

- Strip flat cable.

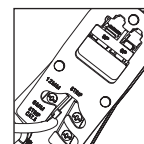

- Strip CAT.5 round cable.

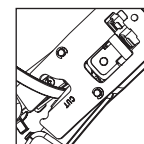

- Cut cable network.

WIRE CRIMPING TOOL

225 mm

9"



Ref 296-063

~~78,26 €~~ 45,81 €

- Bootlace terminal crimping tool. Insulated / Non-insulated terminals.
- Displaced axis to multiply the tightening torque and reduce efforts.
- Semi-circular clamps.
- Bi material handle.
- 0.5 - 0.75 - 1 - 1.5 - 2.5 - 4 - 6 - 10 - 16 mm²

NEW

WIRE CRIMPING TOOL

150 mm

6"



Ref 296-065

~~58,61 €~~ 34,31 €

- Bootlace terminal crimping tool.
- Insulated / Non-insulated terminals.
- Displaced axis to multiply the tightening torque and reduce efforts.
- Spring bi-material handle.
- 0.25 - 0.50 - 0.75 - 1 - 1.5 - 2.5 mm²

NEW

TERMINAL CRIMPING TOOL

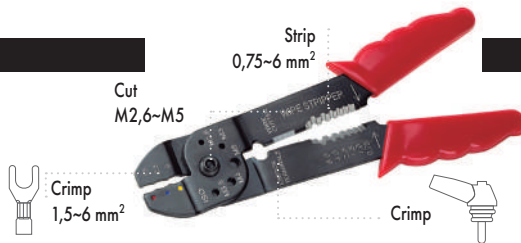

▶ 250 mm Ref 296-056
~~16,06 €~~ 9,44 €

RATCHET

CABLE CUTTERS

52 mm

280 mm

- Forged steel ratchet cable cutters.
- For cutting single and multi-strand copper and aluminium cables.
- Specific to work in difficult access places.
- Hardened cutting edges.
- Security lock.
- Lever to release the pressure.
- Bi-material handle with support area.

Cu 300 mm²
Al 400 mm²

L mm Ref
▶ 280 295-021

~~387,11 €~~ 227,72 € ▶



PROFESSIONAL CABLE STRIPPER



- Fully ground SK2 Blade
- PP & TPR anti-slip grip
- Adjustable cutting depth

L mm mm Ref
▶ 190 8~28 296-031

~~24,39 €~~ 14,35 € ▶



ELECTRICIAN KNIFE



195 mm

Inox

L mm Ref
▶ 195 296-021

~~19,54 €~~ 11,50 € ▶



CABLE CUTTERS



Cr-V



L mm mm² A Max. Ref
▶ 530 250 23,6 295-014

~~231,94 €~~ 135,75 € ▶

- For cutting of single and multi-strand copper and aluminium cables without assembling.
- Hardened cutting edges.
- Tubular steel handle.

A max.



SCREWDRIVERS INSULATED 1000V

- Insulated Screwdriver 1000V
- Insulated Round Blade
- VDE Certificate with Guarantee
- 56 HRc



7 SCREWDRIVERS INSULATED 1000V

- Milled 3 · 4 · 5,5 · 6,5
- PH0 · PH1 · PH2



Ref 360-001
~~74,22 €~~ **43,66 €**

6 SCREWDRIVERS INSULATED 1000V

- Milled 3 · 4 · 5,5 · 6,5
- PH1 · PH2



Ref 360-005
~~66,70 €~~ **38,26 €**

SET ZIPPING WITH 5 TOOLS INSULATED 1000V

- Milled 4 · 5,5
- PZ1 · PZ2



Insulated Diagonal Cutting Plier
Ref. 255-160

Ref 360-008
~~88,69 €~~ **51,91 €**

SET ZIPPING

3 INSULATED PLIERS



160 mm



180 mm



160 mm



Ref 250-002
~~123,71 €~~ **70,96 €**

INTERCHANGEABLE PROFESSIONAL SCREWDRIVER SET 14 PIECES

- 1 Handle
- 1 Cup
- 1 Tester
- 11 Interchangeable Blades:

• 2,5 · 3,5 · 4,0 · 5,5 · 6,5

• PH0 · PH1 · PH2

• T10 · T15 · T20



Ref 360-012
~~77,83 €~~ **45,78 €**

VDE SET

19 PIECES



390 mm
675 mm
705 mm

Ref 080-001
~~267,67 €~~ **157,46 €**



Insulated long nose plier with cut 251-200



Insulated wire stripping plier 257-160



4 Precision Screwdrivers + cups



Tester 396-001



2 insulating tape roll



Insulated Milled Screwdriver



Insulated Phillips Screwdriver

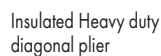

Insulated Heavy duty diagonal plier 255-160



Insulated combination plier 250-180

360-025-075
360-040-100
360-055-125
360-065-150
360-080-175

361-PH0-060
361-PH1-080
361-PH2-100

INSULATED SOCKET SET 20 PIECES



80 mm
320 mm
415 mm



10 · 11 · 12 · 13 · 14 · 16 · 17 · 18 · 19 · 21 · 22 · 24 · 27

Sockets Bits
Ratchet Handle L 250 mm
Extension 250 mm
Sliding "T" L 200 mm

4 · 5 · 6 · 8 · L 120 mm



Ref 5331-001
~~577,13 €~~ **339,49 €**

INDUSTRIAL PLUS SERIES

SCREWDRIVER

- Anti-slip polyurethane
- High resistance polyamid
- Double reinforcement
- Hex blade & hex bolster
- 58 HRC hardness

S2



HIGHER STEADINESS

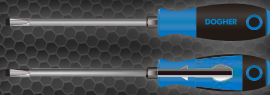

6 SCREWDRIVERS

INDUSTRIAL PLUS SERIES

Milled
3 · 4 · 5 · 6

PH1 · PH2

Ref 300-001

~~62,51 €~~ **35,85 €**



SCREWDRIVERS

PROFESSIONAL SERIES

Round Blade
Bi-material handle
56 HRC

5 SCREWDRIVERS

PROFESSIONAL SERIES

CrMo



Milled
5,5 · 6,5

Ref 330-001

PH1 · PH2 · PH3 ~~43,38 €~~ **25,51 €**

7 SCREWDRIVERS

PROFESSIONAL SERIES

CrMo



Stamped
3 · 4 · 5,5 · 6,5

Ref 330-003

PH0 · PH1 · PH2 ~~49,02 €~~ **28,84 €**

7 SCREWDRIVERS

PROFESSIONAL SERIES

CrMo



Stamped
3 · 4 · 5,5 · 6,5

Ref 330-004

PZ0 · PZ1 · PZ2 ~~50,53 €~~ **29,72 €**

6 SCREWDRIVERS

PROFESSIONAL SERIES

CrMo



Milled
2,5 · 3 · 3,5 · 4 · 5,5 · 6,5

Ref 331-001

~~41,23 €~~ **24,13 €**

6 SCREWDRIVERS

PROFESSIONAL SERIES

CrMo



Stamped
2,5 · 3 · 4 · 5,5 · 6,5 · 8

Ref 330-009

~~47,19 €~~ **27,62 €**

6 SCREWDRIVERS

GO-THROUGH PROFESSIONAL SERIES

CrMo



Stamped
5,5 · 6,5 · 8

PH1 · PH2 · PH3

Ref 375-005

~~75,28 €~~ **44,06 €**

PRECISION

SCREWDRIVERS

Round Blade
Bi-Material Handle
56 HRC

CrMo



1,5 · 2 · 2,5 · 3

Ref 380-002

PH00 · PH0 · PH1 ~~40,38 €~~ **23,75 €**

7 PRECISION

SCREWDRIVERS



PICK

HOOK

6 Pcs



- Hook Pick
- Straight Pick
- 90° Pick
- Angle Hook Pick
- O-Ring

Ref 330-101

~~68,63 €~~ **40,16 €**

IMPACT

SCREWDRIVER BITS

- S2 high technology steel
- Max torque resistance
- High tenacity
- Specific geometry maximum durability

30 mm 1/4" S2



Bluefire

IMPACT SCREWDRIVER BITS

PHILLIPS

1/4"



▶ PH2	2	Ref 427-PH2-2	11,87 €	6,99 €
-------	---	---------------	--------------------	--------

IMPACT SCREWDRIVER BITS

POZIDRIV

1/4"



▶ PZ2	2	Ref 427-PZ2-2	11,87 €	6,99 €
-------	---	---------------	--------------------	--------

IMPACT SCREWDRIVER BITS

TORX

1/4"



▶ T10	2	Ref 427-T10-2	12,08 €	7,10 €
T15	2	427-T15-2	12,08 €	7,10 €
T20	2	427-T20-2	12,08 €	7,10 €
T25	2	427-T25-2	12,08 €	7,10 €
T30	2	427-T30-2	12,08 €	7,10 €
T40	2	427-T40-2	12,08 €	7,10 €

• Minimum order qty

NUT DRIVER KITS

& MAGNETIC BIT HOLDERS

MAGNETIC NUT DRIVERS

KITS

3 Magnetic Nut Drivers 50 mm 8 · 10 · 13

1/4"



▶	Ref 440-001	20,81 €	12,24 €
---	-------------	--------------------	---------

IMPACT MAGNETIC BIT HOLDER

WITH RING

60 mm 1/4" 1/4"

∅ 15



L mm	▶ 60	1	Ref 443-002	19,22 €	11,31 €
------	------	---	-------------	--------------------	---------

MAGNETIC NUT DRIVERS

& HOLDERS KITS

3 Magnetic Nut Drivers 50 mm 6 · 7 · 8 · 10 · 13
2 Holders 50-74 mm

1/4"



▶	Ref 440-007	56,74 €	33,37 €
---	-------------	--------------------	---------

HAMMER USE MAGNETIC BIT HOLDER

WITH RING SDS PLUS

78 mm 1/4"

SDS Plus



L mm	▶ 78	1	Ref 445-001	15,76 €	9,26 €
------	------	---	-------------	--------------------	--------

MAGNETIC BIT HOLDER

WITH RING

1/4" 1/4"



L mm	▶ 50	1	Ref 443-050	6,42 €	3,76 €
	▶ 74	1	443-074	11,43 €	6,72 €

**FLEXIBLE EXTENSION
BIT HOLDER**

1/4" 1/4" 300 mm



Ref 444-001

~~32,53 €~~ 19,13 €

**OFFSET BIT HOLDER
FOR 1/4" BITS**

- Suitable for screwdriver bits and hex shank drill bits
- Designed for a comfortable work in limited spaces
- To be used exclusively in cordless drivers

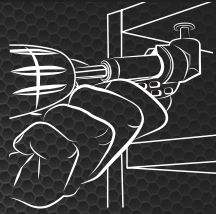

Ref 443-001

~~32,31 €~~ 19,00 €

**FLEXIBLE HEAD RATCHET
SCREWDRIVER**

- Reversible
- Ergonomic bi-material handle
- Safety fixing Ball
- Unlocking button

1/4" CrV



0° - 45° - 90° POSITIONS



▶ 180mm Ref 343-007
~~19,89 €~~ 11,69 €

**58 PIECES
RATCHETING SCREWDRIVER BIT SET**

3 · 4 · 4,5 · 5 · 6 · 7 · 8

PH0 · PH1 · PH2 · PH3

PZ0 · PZ1 · PZ2 · PZ3

T5 · T6

TS7 · TS8 · TS9 · TS10 · TS15
TS20 · TS25 · TS30 · TS40

HX1,5

HXS2,0 · HXS2,5 · HXS3,0
HXS4,0 · HXS5,0 · HXS6,0

1 · 2 · 3

XZN4 · XZN5 · XZN6 · XZN8

R0 · R1 · R2 · R3

TW1 · TW2 · TW3 · TW4

TQ06 · TQ08 · TQ10

4 · 6 · 8 · 10

S2



Adapter

1/4" ◀ ▶ 1/4" (509-030)

Magnetic Bit Holder
with Ring 60 mm
Screwdriver Ref. 343-007

▶ Ref 438-008
~~71,19 €~~ 41,88 €

**TELESCOPING INSPECTION
MIRROR**



L min-max. 240-930 Ø 56,5 mm

▶ Ref 930-001
~~16,17 €~~ 9,51 €

**TELESCOPIC
MAGNETIC PICK UP TOOL**

680 g







L mm → ◉ ← mm Ref
▶ 635 7 343-020

~~10,91 €~~ 6,41 € ▶

32 PIECES

SCREWDRIVER BIT SET & BIT HOLDER

-  T06 · T07 · T08 · T09 · T10 · T15
T20 · T25 · T27 · T30 · T40
-  HX3 · HX4 · HX5 · HX6
-  3 · 4 · 5 · 6 · 7
-  PH0 · PH1 · PH2 (x3) · PH3
-  PZ0 · PZ1 · PZ2 · PZ3

Adapter 1/4"  1/4" (509-030)
Magnetic Bit Holder with Ring: 60 mm



1/4" 25 mm

Ref 438-001











~~41,94 €~~ 24,66 €

INTERCHANGEABLE PROFESSIONAL SCREWDRIVER SET

1 Blade holder handle
10 interchangeable double ended bits

20 screwdrivers in 1 · Double bit blades
The screwdriving solution in your pocket !!!











-  3 · 4
-  PH0 · PH1
-  PZ0 · PZ1
-  T10 · T15
-  HX2 · HX3
-  5,5 · 6,35
-  PH2 · PZ2
-  PZ/FL1 · PZ/FL2
-  T20 · T25
-  HX4 · HX5

Ref 330-050

~~70,99 €~~ 41,75 €

51 PIECES

PRECISION SCREWDRIVER BIT SET

-  1 · 1,5 · 2 · 2,5 · 3 · 3,5 · 4
-  PH000 · PH00 · PH0 · PH1
-  PZ000 · PZ00
PZ0 · PZ1 · PZ2
-  T3 · T4 · T5 · T6 · T7
T8 · T9 · T10 · T15 · T20
-  TS7 · TS8 · TS9 · TS10
TS15 · TS20
-  HX0,7 · HX0,9 · HX1,3
HX1,5 · HX2,0 · HX2,5
HX3,0 · HX3,5 · HX4,0
-  HS2,0 · HS2,5
HS3,0 · HS4,0
-  HR1,5 · HR2,0 · HR2,5
HR3,0 · HR4,0

Ref 380-005

~~75,67 €~~ 44,50 €



FLEXIBLE MAGNETIC PICK UP TOOL

NEW

680 mm 27" 1kg

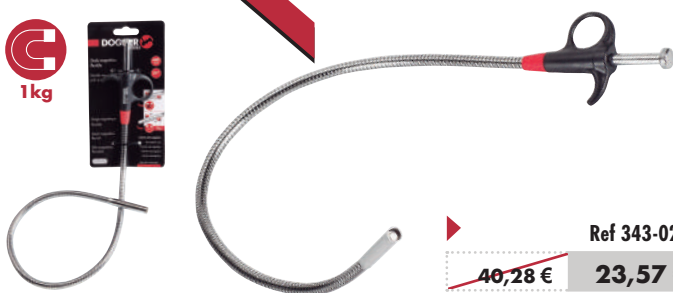

Ref 343-021

~~40,28 €~~ 23,57 €

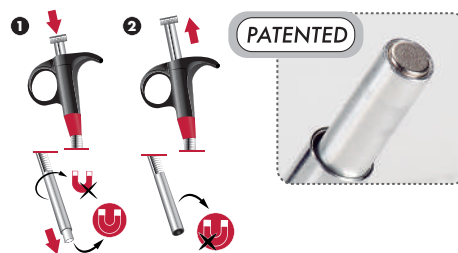

PATENTED

• Anti Magnetic Cover.

FLEXIBLE 3 CLAWS PICK UP TOOL

NEW

700 mm 27,5" 1,2kg

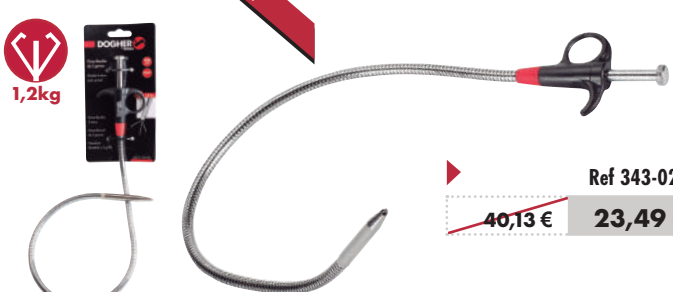

Ref 343-026

~~40,13 €~~ 23,49 €

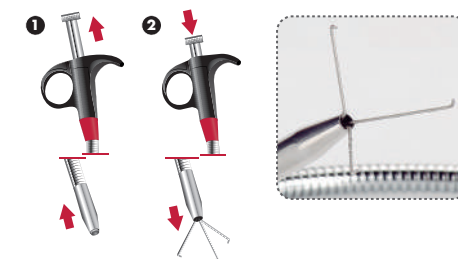

ADJUSTABLE WRENCHES



- Maximum & precise adjustment of the jaws
- Higher rigidity when tightening
- Accurate screw drive, no looseness
- 15° angle, increases torque with less effort

15°



SPANISH ADJUSTABLE WRENCH



L mm	L"	mm	Ref		
▶ 150	6	24	491-150	33,27 €	19,57 €
200	8	29	491-200	37,13 €	21,84 €
250	10	33	491-250	45,85 €	26,97 €
300	12	38	491-300	58,04 €	34,15 €
400	16	50	491-400	96,53 €	56,78 €
500	20	62	491-500	175,24 €	103,09 € ▶

PROFESSIONAL ADJUSTABLE PRO WRENCH



L mm	L"	mm	Ref		
▶ 100	4	17	493-100	23,33 €	13,38 €
150	6	24	493-150	24,02 €	13,76 €
200	8	29	493-200	27,57 €	15,81 €
250	10	33	493-250	33,71 €	19,34 €
300	12	38	493-300	44,19 €	25,35 €
380	15	50	493-380	75,18 €	43,12 €
450	18	60	493-450	118,05 €	67,71 €
600	24	70	493-600	293,29 €	168,21 € ▶

EXTRA WIDE ADJUSTABLE WRENCH



L mm	L"	mm	Ref		
▶ 150	6	34	492-150	34,47 €	19,76 €
200	8	38	492-200	37,39 €	21,44 €
250	10	50	492-250	45,80 €	26,26 € ▶

ADJUSTABLE STD WRENCH



L mm	L"	mm	Ref		
▶ 100	4	13	4930-100	16,37 €	9,40 €
150	6	19	4930-150	16,53 €	9,49 €
200	8	24	4930-200	19,09 €	10,94 €
250	10	28	4930-250	23,97 €	13,74 €
300	12	34	4930-300	30,95 €	17,75 €
380	15	43	4930-380	55,60 €	31,88 €
450	18	52	4930-450	85,48 €	49,03 €
600	24	62	4930-600	180,85 €	103,72 € ▶

ADJUSTABLE WRENCHES



200 mm • 8" **Alligator**

32 mm M3-M10 CrV



Alligator

▶ Ref 4931-200
~~40,98 €~~ **24,10 €**

DOUBLE OPEN END WRENCH



8 DOUBLE OPEN END WRENCHES

6x7 · 8x9 · 10x11 · 12x13 · 14x15 · 16x17 · 18x19 · 20x22



390 x 300 mm

Ref 450-001
~~77,05 €~~ **45,32 €**



Ref 450-018
~~79,05 €~~ **46,50 €**

10 DOUBLE OPEN END WRENCHES

6x7 · 8x9 · 10x11 · 12x13 · 14x15
16x17 · 18x19 · 20x22 · 21x23 · 24x27



Ref 450-020
~~111,48 €~~ **65,57 €**

12 DOUBLE OPEN END WRENCHES

6x7 · 8x9 · 10x11 · 12x13 · 14x15 · 16x17 · 18x19 · 20x22 · 21x23 · 24x27 · 25x28
· 30x32



Ref 450-002
~~157,50 €~~ **92,65 €**

620 x 350 mm

DOUBLE ENDED HEX SOCKET WRENCH SETS

8 DOUBLE ENDED HEX SOCKET WRENCHES

6x7 · 8x9 · 10x11 · 12x13 · 14x15 · 16x17 · 18x19 · 20x22



430 x 380 mm

Ref 460-002
~~178,03 €~~ **102,10 €**

Cr-V



12 DOUBLE ENDED HEX SOCKET WRENCHES

6x7 · 8x9 · 10x11 · 12x13 · 14x15 · 16x17
18x19 · 20x22 · 21x23 · 24x26 · 25x28 · 30x32



520 x 390 mm

Ref 460-004
~~363,46 €~~ **208,46 €**

DOUBLE RING OFFSET WRENCHES

8 DOUBLE RING OFFSET WRENCHES

6x7 · 8x9 · 10x11 · 12x13 · 14x15 · 16x17 · 18x19 · 20x22



390 x 380 mm

Ref 453-002
~~139,57 €~~ **82,10 €**

Cr-V



75° 75°

12 DOUBLE RING OFFSET WRENCHES

6x7 · 8x9 · 10x11 · 12x13 · 14x15 · 16x17
18x19 · 20x22 · 21x23 · 24x27 · 25x28 · 30x32



620 x 480 mm

Ref 453-003
~~291,37 €~~ **171,40 €**

COMBINATION

WRENCHES

- Maximum load distribution
- Quick tightening
- Maximum performance without wear
- Decreases damage to nuts and bolts

- Longer lifetime of the wrench
- Maximum contact surface
- Homogeneous stress distribution

CrV



Effect of stress:

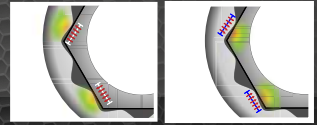

- On the wrench
- On the nut

8 COMBINATION

WRENCHES

8 · 10 · 11 · 12 · 13 · 14 · 17 · 19

Ref 451-018

~~89,54 €~~ 52,68 €



12 COMBINATION

WRENCHES

8 · 9 · 10 · 11 · 12 · 13 · 14 · 15 · 16 · 17 · 18 · 19

Ref 451-022

~~132,80 €~~ 78,12 €



14 COMBINATION

WRENCHES

8 · 9 · 10 · 11 · 12 · 13 · 14
17 · 19 · 22 · 24 · 27 · 30 · 32

Ref 451-002

~~228,23 €~~ 134,25 €



650 x 440 mm

17 COMBINATION

WRENCHES

6 · 7 · 8 · 9 · 10 · 11 · 12 · 13 · 14 · 15
16 · 17 · 18 · 19 · 20 · 21 · 22

Ref 451-003

~~197,69 €~~ 110,47 €



470 x 450 mm

18 COMBINATION

WRENCHES

8 · 9 · 10 · 11 · 12 · 13 · 14 · 15 · 16
18 · 19 · 22 · 23 · 24 · 26 · 27 · 30 · 32

650 x 480 mm

Ref 451-004

~~296,54 €~~ 174,43 €



24 COMBINATION

WRENCHES

6 · 7 · 8 · 9 · 10 · 11 · 12 · 13 · 14 · 15 · 16 · 17
18 · 19 · 20 · 21 · 22 · 24 · 26 · 27 · 28 · 30 · 32 · 36

650 x 580 mm

Ref 451-005

~~425,68 €~~ 250,40 €

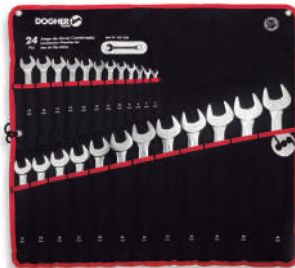

26 COMBINATION

WRENCHES

6 · 7 · 8 · 9 · 10 · 11 · 12 · 13 · 14 · 15 · 16 · 17 · 18 · 19
20 · 21 · 22 · 23 · 24 · 25 · 26 · 27 · 28 · 29 · 30 · 32

650 x 500 mm

Ref 451-006

~~434,35 €~~ 255,50 €



COMBINATION REVERSIBLE GEAR

WRENCHES

CrV

72 (5°)

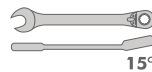

15°



5 COMBINATION REVERSIBLE GEAR

WRENCHES

8 · 10 · 13 · 17 · 19

Ref 457-014

~~180,521 €~~ 106,18 €



7 COMBINATION REVERSIBLE GEAR

WRENCHES

10 · 12 · 13 · 14 · 15 · 17 · 19

Ref 457-001

~~255,65 €~~ 146,62 €



330 x 390 mm

8 COMBINATION REVERSIBLE GEAR

WRENCHES

8 · 10 · 11 · 12
13 · 14 · 17 · 19

Ref 457-018

~~278,48 €~~ 163,82 €



**NON REVERSIBLE
COMBINATION GEAR WRENCH**



**12 COMBINATION GEAR
WRENCHES**

8 · 9 · 10 · 11 · 12 · 13
14 · 15 · 16 · 17 · 18 · 19

▶ Ref 4557-022
~~278,48 €~~ **163,81 €**



**FLEXIBLE
GEAR WRENCHES**



**5 FLEXIBLE
GEAR WRENCHES**

8 · 10 · 13 · 17 · 19

▶ Ref 458-015
~~170,23 €~~ **97,65 €**



**4 IN 1
GEAR WRENCHES**



mm mm Ref
▶ 10x13 17x19 475-10-19

~~41,04 €~~ **24,15 €** ▶



**3 4 IN 1
GEAR WRENCHES**

8x13: 8x10 12x13
9x15: 9x11 14x15
16x19: 16x17 18x19



220 x 330 mm

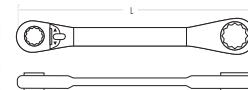

▶ Ref 475-001
~~118,57 €~~ **68,01 €**

**6X6 ANGLED OPEN
SOCKET WRENCH**



**10 6X6 ANGLED OPEN
SOCKET WRENCH**

6 · 7 · 8 · 10 · 11 · 12 · 13 · 14 · 17 · 19

▶ Ref 462-011
~~183,27 €~~ **105,10 €**



**TORQUE
WRENCHES**

**PROFESSIONAL
TORQUE WRENCH**



N°m	mm	L mm	mm	Ref	Price	Price
▶ 1-6	0,05	210	1/4"	625-01-06	241,14 €	141,84 €
2-10	0,1	280	1/4"	625-02-10	256,95 €	151,15 €
10-50	0,25	330	1/4"	625-10-50	268,43 €	157,90 €
10-60	0,5	340	3/8"	626-10-60	283,13 €	166,56 €
20-100	0,5	435	1/2"	627-20-100	310,29 €	182,51 €
40-200	0,5	515	1/2"	627-40-210	317,00 €	186,47 €
80-400	2	615	1/2"	627-70-350	365,16 €	214,79 €
100-600	2,5	1050	3/4"	628-100-500	1.109,41 €	652,59 €
200-1000	5	1250	3/4"	628-200-1000	1.565,41 €	920,82 €
300-1.500	10	1850	1"	629-300-1500	2.779,30 €	1.634,88 €



**STANDARD
TORQUE WRENCH**



N°m	mm	L mm	mm	Ref	Price	Price
▶ 5-25	0,1	280	1/4"	630-05-25	180,93 €	106,43 €
14-203	0,5	450	1/2"	632-14-203	255,55 €	150,32 €
50-350	3	570	1/2"	632-70-350	353,30 €	207,82 €

▶ The wrench can be used CW/CCW direction.

**SUPERPROOF
RATCHET HANDLE**



	L mm	Ref		
	145	510-006	46,79 €	27,51 €
	250	544-006	63,87 €	37,57 €

**RATCHET
HANDLES**



Precision
72Th ratchet



510-001/544-001

	L mm	Ref		
	108	510-002	24,65 €	14,13 €
	145	510-001	30,03 €	17,66 €



510-002/544-002

Short Series Available
Special for difficult access works

	L mm	Ref		
	170	544-002	34,69 €	19,90 €
	250	544-001	52,09 €	30,63 €

**SOCKETS
SOCKET SETS**



UNE 16501:2009 (ISO1711-1)



**10 SOCKETS
SPLINE**

5 • 6 • 7 • 8 • 9 • 10
11 • 12 • 13 • 14



	Ref 511-051	
	55,26 €	32,34 € NEW

**11 SOCKETS
SPLINE AND RATCHET HANDLE**

5 • 6 • 7 • 8 • 9 • 10
11 • 12 • 13 • 14



	Ref 511-061	
	85,29 €	49,93 € NEW

**10 SOCKETS
SPLINE**

9 • 10 • 11 • 12 • 13 • 14 • 15 • 17 • 18 • 19

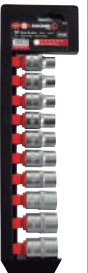

	Ref 546-051	
	84,47 €	49,44 € NEW

**13 SOCKETS SPLINE
RATCHET HANDLE AND EXTENSION**

8 • 9 • 10 • 11 • 12 • 13 • 14 • 15 • 17 • 19 • 21



	Ref 546-061	
	156,59 €	91,65 € NEW

**11 SOCKETS
SPLINE AND RATCHET HANDLE**

9 • 10 • 11 • 12 • 13 • 14 • 15 • 17 • 18 • 19



	Ref 546-062	
	136,56 €	79,93 € NEW



Valid for 50% worn out nuts

SOCKETS

SOCKET & RATCHET HANDLE SETS

IMPACT SOCKETS 1/2"

SPECIAL FOR CAR RIMS



1/2"



17 · 19 · 21



Ref

▶ 575-001 ~~39,78 €~~ **23,40 €**

8 PIECES

3/4" IMPACT SOCKETS LONG SERIES + INCREASING ADAPTOR

19 · 22 · 24 · 27 · 30 · 32 · 36

Increasing Adaptor

3/4" ▶ ◀ 1/2" (594-026)

Ref

▶ 579-001 ~~400,82 €~~ **234,60 €** ▶



3/4"

CrMo



17 PIECES

1/4" HEXAGONAL SOCKETS

CrV

1/4"

4 · 4,5 · 5 · 5,5 · 6 · 7 · 8 · 9
10 · 11 · 12 · 13 · 14

72 Teeth Ratchet Handle

Universal Joint

Extension: 50mm

3-Way Spinner Handle



Ref

▶ 500-001 ~~96,67 €~~ **55,46 €** ▶ 260 x 167 x 62 mm

34 PIECES

1/4" HEXAGONAL SOCKETS

CrV

1/4"

4 · 4,5 · 5 · 5,5 · 6 · 7 · 8 · 9 · 10 · 11 · 12 · 13 · 14

1/4" · Screwdriver Bits

4 · 5,5 · 6,5

PH1 · PH2 · PH3

72 Teeth Ratchet Handle

Universal Joint

Extension: 50 mm

Flexible Extension: 145 mm

3-Way Spinner Handle

Square Drive Bit Holder 1/4"

Palm Driver



Ref

▶ 500-002 ~~138,34 €~~ **79,34 €** ▶ 260 x 167 x 62 mm

47 PIECES

1/4" HEXAGONAL SOCKETS

CrV

1/4"

4 · 4,5 · 5 · 5,5 · 6 · 7 · 8 · 9 · 10 · 11 · 12 · 13 · 14
Long Serie: 8 · 10 · 11 · 13

Socket Bits

T10 · T15 · T20 · T25 · T30 · T40

4 · 5,5 · 6,5

HX3 · HX4 · HX5 · HX6 · HX7 · HX8

PH1 · PH2 · PH3

PZ1 · PZ2 · PZ3

Ref

▶ 500-003 ~~239,83 €~~ **126,97 €** ▶

72 Teeth Ratchet Handle

Universal Joint

Extensions: 50 & 100mm

Spinner Handle

Sliding "T" Handle

Hex Key Wrenches 1,5 · 2 · 2,5

260 x 167 x 62 mm



SOCKETS

SOCKET & RATCHET HANDLE SETS

16 PIECES

3/8" HEXAGONAL SOCKETS



- 8 · 9 · 10 · 11 · 12 · 13
- 14 · 15 · 16 · 17 · 18 · 19

72 Teeth Ratchet Handle
 Universal Joint
 Extension: 75 mm
 Palm Driver



Ref
 516-001 ~~123,76 €~~ **65,53 €** 260 x 167 x 62 mm

34 PIECES

3/8" HEXAGONAL SOCKETS



- 6 · 8 · 10 · 11 · 12 · 13 · 14 · 15 · 16 · 17 · 18 · 19

- 1/4" · Socket Bits T10 · T15 · T20 · T25 · T27 · T30 · T40
- PH0 · PH1 · PH2 · PH3 HX3 · HX4 · HX5 · HX6

72 Teeth Ratchet Handle
 Universal Joint
 Extensions: 75 & 150 mm
 Spinner Handle
 Sliding "T" Handle
 Adapter 1/4" - 3/8"



Ref
 516-003 ~~230,08 €~~ **121,81 €** 260 x 167 x 62 mm

14 PIECES

1/2" HEXAGONAL SOCKETS



- 10 · 11 · 12 · 13 · 14 · 15
- 16 · 17 · 18 · 19 · 21 · 22

72 Teeth Ratchet Handle
 Universal Joint

Ref
 531-001 ~~123,54 €~~ **70,85 €** 260 x 167 x 62 mm



41 PIECES

1/2" HEXAGONAL OR BIHEXAGONAL SOCKETS



- 8 · 9 · 10 · 11 · 12 · 13 · 14 · 15 · 16 · 17 · 18 · 19 · 21 · 22 · 24 · 27 · 30 · 32

- 5/16" · Screwdriver Bits T40 · T45 · T50 · T55 · T60
- PH3 · PH4 HX7 · HX8 · HX10 · HX12
- PZ3 · PZ4 8 · 10 · 12

72 Teeth Ratchet Handle
 Universal Joint
 Extensions: 125 & 250 mm
 Square Drive Bit Holder 5/16" - 1/2"
 3-Way Adapter 3/8" - 1/2"
 Palm Driver

Ref
 531-003 ~~256,59 €~~ **147,18 €**
 530-003 ~~256,59 €~~ **147,18 €** 385 x 280 x 87 mm



16 PIECES

3/4" HEXAGONAL SOCKETS

- 19 · 22 · 23 · 24 · 27 · 30 · 32 · 36 · 38 · 41 · 46 · 50

24 Teeth Ratchet Handle -500 mm
 Extensions: 100 & 200 mm
 Sliding "T" Handle

Ref
 549-001 ~~644,32 €~~ **341,10 €**



SOCKETS

SOCKET & RATCHET HANDLE SETS

76 PIECES

1/4" & 1/2" HEXAGONAL SOCKETS



▶ **1/4"** Socket Bits 4 · 4,5 · 5 · 5,5 · 6 · 7 · 8 · 9 · 10 · 11 · 13

- | | |
|-------------------------|-----------------------------------|
| 1/4" · Screwdriver Bits | T10 · T15 · T20 · T25 · T27 · T30 |
| PH0 · PH1 · PH2 · PH3 | HX2 · HX3 · HX4 · HX5 · HX6 · HX7 |
| PZ2 · PZ3 | 3 · 4,5 · 5,5 · 6,5 |

▶ **1/2"** Socket Bits 10 · 11 · 12 · 13 · 14 · 15 · 16 · 17 · 19 · 21 · 24 · 27 · 30 · 32

- | | |
|--------------------------|-----------------------------|
| 5/16" · Screwdriver Bits | T40 · T45 · T50 · T55 · T60 |
| PH3 · PH4 | HX8 · HX10 · HX12 |
| PZ3 · PZ4 | 8 · 10 · 12 |

72 Teeth Ratchet Handle 1/4" & 1/2"
 Universal Joint 1/4" & 1/2"
 Extensions: 1/4" & 1/2": 50 & 100 - 125 & 250 mm
 3-Way Spinner Handle 1/4"
 Square Drive Bit Holder 1/4" & 1/2"
 1/4" ▶ ◀ 1/4" 5/16" ▶ ◀ 1/2"
 Palm Driver 1/4" & 1/2"
 3-Way Spinner Handle 1/2"
 3/8" ▶ ◀ 1/2"



440 x 305 x 92 mm

Ref

▶ **500-025** ~~364,86 €~~ **193,16 €** ▶

94 PIECES

1/4" & 1/2" HEXAGONAL SOCKETS



▶ **1/2"** 10 · 11 · 12 · 13 · 14 · 15 · 16 · 17 · 18 · 19 · 20 · 21 · 22 · 24 · 27 · 30 · 32
 Long Series: 14 · 15 · 17 · 19 Spark Plug: 16 · 21

- | | |
|------------------------|--------------------------|
| 5/16" Screwdriver Bits | T40 · T45 · T50 · T55 |
| PH3 · PH4 | HX8 · HX10 · HX12 · HX14 |
| PZ3 · PZ4 | 8 · 10 · 12 |

▶ **1/4"** Socket 4 · 4,5 · 5 · 5,5 · 6 · 7 · 8 · 9 · 10 · 11 · 12 · 13 · 14
 Long Series: 6 · 7 · 8 · 9 · 10 · 11 · 12 · 13

- | | |
|-------------|----------------------------------|
| Socket Bits | T8 · T10 · T15 · T20 · T25 · T30 |
| PH1 · PH2 | HX3 · HX4 · HX5 · HX6 |
| PZ1 · PZ2 | 4 · 5,5 · 7 |

72 Teeth Ratchet Handle 1/4" & 1/2"
 Universal Joint 1/4" & 1/2"
 Extensions: 50 & 100 - 125 & 250 mm 1/4" & 1/2"
 Spinner Handle 1/4"
 Flexible Extension 1/4"
 Sliding "T" Handle 1/4"
 Bit-Holder 5/16" ▶ ◀ 1/2"
 Adapter 3/8" ▶ ◀ 1/2"
 Hex Key Wrenches 1,5 · 2 · 2,5



380 x 300 x 84 mm

Ref

▶ **500-030** ~~148,29 €~~ **87,24 €** ▶

108 PIECES

1/4" & 1/2" HEXAGONAL SOCKETS



▶ **1/4"** 4 · 4,5 · 5 · 5,5 · 6 · 7 · 8 · 9 · 10 · 11 · 12 · 13 · 14
 Long Series: 6 · 7 · 8 · 9 · 10 · 11 · 12 · 13
 E4 · E5 · E6 · E7 · E8

- | | |
|--------------------|--|
| 1/4" · Socket Bits | T8 · T10 · T15 · T20 · T25 · T27 · T30 |
| PH1 · PH2 | HX3 · HX4 · HX5 · HX6 |
| PZ1 · PZ2 | 4 · 5,5 · 6,5 |

72 Teeth Ratchet Handle 1/4" & 1/2"
 Universal Joint 1/4" & 1/2"
 Extensions 1/4" & 1/2": 50 & 75 - 125 & 250 mm
 Spinner Handle 1/4"
 Sliding "T" Handle 1/4"
 3-Way Spinner Handle 1/2" 3/8" ▶ ◀ 1/2"
 Square Drive Bit Holder 1/2" 5/16" ▶ ◀ 1/2"
 Hex Key Wrenches 1,5 · 2 · 2,5

Ref

▶ **500-026** ~~651,22 €~~ **363,91 €** ▶

385 x 274 x 88 mm



SOCKETS

SOCKET & RATCHET HANDLE SETS

151 PIECES

1/4", 3/8" & 1/2" HEXAGONAL SOCKETS



- ▶ 4 · 4,5 · 5 · 5,5 · 6 · 7 · 8 · 9 · 10 · 11 · 12 · 13 · 14
Long Series: 4 · 5 · 6 · 7 · 8 · 9 · 10
- ▶ T4 · T5 · T6 · T7 · T8

- Socket Bits T8 · T9 · T10 · T15 · T20 · T25 · T27 · T30
- ▶ PH0 · PH1 · PH2 HX3 · HX4 · HX5 · HX6
 - ▶ PZ0 · PZ1 · PZ2 4 · 5,5 · 6,5 · 7
 - ▶ TS8 · TS9 · TS10 · TS15 · TS20 · TS25 · TS27 · TS30

- ▶ 10 · 11 · 12 · 13 · 14 · 15 · 16 · 17 · 18 · 19 Spark Plug: 18
Long Series: 10 · 11 · 12 · 13 · 14 · 15
- ▶ T10 · T11 · T12 · T14 · T16 · T18

- ▶ 10 · 11 · 12 · 13 · 14 · 15 · 16 · 17 · 18 · 19 · 20 · 21 · 22 · 24 · 27 · 30 · 32
Long Series: 16 · 17 · 18 · 19 · 22 Spark Plug: 16 · 21
- ▶ T20 · T24

- 5/16" Screwdriver Bits T40 · T45 · T50 · T55 · T60 · T70
- ▶ PH3 · PH4 HX7 · HX8 · HX10 · HX12 · HX14
 - ▶ PZ3 · PZ4 8 · 10 · 12
 - ▶ TS40 · TS45 · TS50 · TS55 · TS60 · TS70

- 72 Teeth Ratchet Handle 1/4", 3/8" & 1/2"
- Universal Joint 1/4", 3/8" & 1/2"
- Extensions 1/4", 3/8" & 1/2": 50 & 100 - 125 - 125 & 250
- Spinner Handle 1/4"
- Sliding "T" Handle 1/4"
- 3-Way Adapter 1/2" 3/8" 1/2"
- Square Drive Bit Holder 1/2" & 3/8" 5/16" 1/2" / 3/8"
- Hex Key Wrenches 1,27 · 1,5 · 2 · 2,5 · 3 · 4 · 5 1/2"



Ref 500-027 ~~898,64 €~~ **475,75 €** ▶ 435 x 305 x 95 mm

KEY WRENCH SETS

9 KEY WRENCH

- TORX**
- ▶ T10 · T15 · T20 · T25
T27 · T30 · T40 · T45 · T50

▶ Ref 606-009
~~32,53 €~~ **19,13 €**

▶ Ref 608-009
~~47,83 €~~ **28,13 €**

Extra-Long Series

9 KEY WRENCH

- TORX TAMPER**
- ▶ TS10 · TS15 · TS20 · TS25 · TS27 · TS30 · TS40 · TS45 · TS50

▶ Ref 609-009
~~39,50 €~~ **23,24 €**

▶ Ref 611-009
~~55,86 €~~ **32,87 €**

Extra-Long Series

9 KEY WRENCH

- HEX**
- ▶ 1,5 · 2 · 2,5 · 3
4 · 5 · 6 · 8 · 10 mm

▶ Ref 600-009
~~16,30 €~~ **9,34 €**

▶ Ref 602-009
~~24,58 €~~ **14,46 €**

Extra-Long Series



9 KEY WRENCH

- BALL NOSE HEX**
- ▶ 1,5 · 2 · 2,5 · 3 · 4 · 5 · 6 · 8 · 10 mm

▶ Ref 603-009
~~21,83 €~~ **12,84 €**

Extra-Long Series



▶ Ref 605-009



▶ Ref 605-069



▶ Ref 607-079

~~33,73 €~~ **19,84 €** ~~40,70 €~~ **23,94 €** ~~31,77 €~~ **18,68 €**

15 KEY WRENCH

- BALL NOSE HEX**
- ▶ 1,27 · 1,5 · 2 · 2,5 · 3 · 3,5
4 · 4,5 · 5 · 5,5 · 6 · 7 · 8
9 · 10 mm

▶ Ref 605-089
~~54,72 €~~ **32,19 €**



LEVELS

3 VIAL MAGNETIC SPIRIT LEVEL

LEVEL

- AI
- 3 Vial 45° · 90° · 180°
- Magnetized



0,5 mm/m



L mm	Ref	Price	Price
▶ 400	783-02-400	22,90 €	13,47 €
600	783-02-600	29,73 €	17,49 €
800	783-02-800	32,58 €	19,16 €
1000	783-02-1000	40,28 €	23,69 €
1200	783-02-1200	51,15 €	30,09 €
1800	783-02-1800	76,50 €	45,00 € ▶

2 VIAL TRAPEZOID SPIRIT LEVEL

LEVEL

AI

0,5 mm/m



L mm	Ref	Price	Price
▶ 400	784-01-400	20,36 €	11,97 €
600	784-01-600	26,45 €	15,54 € ▶

- 2 Vial 90° · 180°

3 VIAL TORPEDO LEVEL

LEVEL

AI

0,5 mm/m



L mm	Ref	Price	Price
▶ 250	785-001	25,74 €	15,13 € ▶

- 3 Vial 45° · 90° · 180°
- Shockproof Protection

DIGITAL CLAMP METER

METER

CAT II 750V ~ 1000A ~ MAX

- Measures AC current, AC & DC, Voltage & resistance.
- Overload protection.
- Data-hold function.
- Audible continuity.
- Low battery indication.
- LCD display.
- Includes 10A test leads & soft case.
- Requires 1x 9V battery.
- IEC 61010
- Pollution Grade II



▶	Ref 795-001	46,94 €	27,62 €
---	-------------	--------------------	---------

DIGITAL MULTIMETER

MULTIMETER

000V..... 750V ~

- Measures AC current, AC & DC Voltage & resistance.
- Checks continuity diodes & NPN/PNP transistors.
- Supplied with test leads.
- LCD display.
- Requires 1x 9V battery (Not included).
- IEC 61010
- Pollution Grade II



▶	Ref 795-002	41,59 €	24,47 €
---	-------------	--------------------	---------

VOLTAGE TESTER

TESTER

3 in 1

CAT II 600V

- 900 mm wire.
- Designed to be used indoor at temperature 5°C to 40°C.
- Altitude up to 2.000 m.
- IEC 61010
- Pollution Grade II

900 mm

V..... 150V · 300V · 500V

V ~ 110V · 220V · 380V

▶	Ref 795-003	17,05 €	10,03 €
---	-------------	--------------------	---------



**PROFESSIONALS
MEASURING TAPES**

- Metal Metric Tape
- Manual Lock Button
- Rubber Impact Protection
- Safety Sirap included

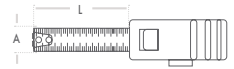

**MEASURING TAPE
DOUBLE FACE**

Class II



- Double face marking

L m	A mm	Ref	8,68 €	5,22 €
3	16	771-03		
5	19	771-05	13,23 €	7,78 €

**MEASURING TAPE
STD**

Class II



L m	A mm	Ref	5,39 €	3,16 €
3	16	778-03		
5	19	778-05	7,29 €	4,29 €

**FIBERGLASS
MEASURING TAPE**



Class III



L m	A mm	Ref	27,32 €	16,07 €
30	13	779-030		
50	13	779-050	31,83 €	18,72 €

**FIBERGLASS
MEASURING TAPE**



Class III



- Tape collection speed.

L m	A mm	Ref	40,38 €	23,75 €
30	15	780-030		
50	15	780-050	55,65 €	32,74 €

Double face marking

**PROFESSIONAL STAINLESS STEEL
SQUARE**

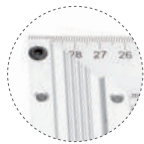

L mm	A mm	B mm	Ref	18,10 €	10,65 €
250	40	1	793-01-250		
300	40	1	793-01-300	20,66 €	12,15 €
350	40	1	793-01-350	21,14 €	12,43 €
400	40	1	793-01-400	21,92 €	12,90 €

**DIGITAL
CALIPER**

0,01 mm



Instructions Manual Included
mm & Inches Measurement

Inox



mm	Ref	92,20 €	54,24 €
0 ~ 150	797-150		

PERCUSSION

HAMMERS

UPE HAMMER KNOCK IN HEAD HICKORY HANDLE DEAD BLOW

UPE

Ø mm	Ref	36,19 €	21,29 €
35	740-35	36,19 €	21,29 €
40	740-40	47,78 €	28,10 €
50	740-50	63,17 €	37,16 €

· Spare head



UPE HAMMER HICKORY HANDLE

UPE

Ø mm	Ref	32,57 €	19,16 €
35	7331-35	32,57 €	19,16 €
40	7331-40	42,93 €	25,25 €
50	7331-50	56,86 €	33,44 €

· Spare head



PU HAMMER METAL HANDLE DEAD BLOW

PU

Ø mm	Ref	42,56 €	25,03 €
35	7310-35	42,56 €	25,03 €
40	7310-40	58,49 €	34,40 €
50	7310-50	68,70 €	40,41 €

· Spare head



CARPENTER HAMMER FIBERGLASS HANDLE

g	A mm	L mm	Ref	18,36 €	10,79 €
100	18	270	703-100	18,36 €	10,79 €
135	20	265	703-135	19,93 €	11,72 €
180	22	250	703-180	21,72 €	12,78 €
320	25	290	703-320	22,89 €	13,47 €
420	30	335	703-420	23,88 €	14,04 €



SHUTTERING HAMMERS FIBERGLASS HANDLE



Magnet



g	L mm	Ref	33,45 €	19,68 €
700	500	711-700	33,45 €	19,68 €



BALL PEN HICKORY HANDLE

	g	A mm	L mm	Ref	17,52 €	10,31 €
B	340	28	320	700-340	17,52 €	10,31 €
C	455	30	360	700-455	21,18 €	12,46 €
D	560	32	350	700-560	24,04 €	14,13 €
E	680	34	375	700-680	26,65 €	15,68 €
F	910	38	405	700-910	28,84 €	16,96 €
G	1130	40	410	700-1130	32,00 €	18,82 €
H	1360	40	410	700-1360	32,66 €	19,21 €



BALL PEN FIBERGLASS HANDLE

	g	A mm	L mm	Ref	28,05 €	16,41 €
B	340	28	310	701-340	28,05 €	16,41 €
C	455	30	305	701-455	29,10 €	17,12 €
D	560	32	315	701-560	31,76 €	18,68 €
E	680	34	340	701-680	34,65 €	20,37 €
F	910	38	370	701-910	40,68 €	23,93 €
G	1130	40	375	701-1130	47,98 €	28,09 €
H	1360	40	375	701-1360	50,23 €	29,54 €



PERCUSSION

HAMMERS

BIG HEAD SLEDGE HAMMERS

FIBERGLASS HANDLE



g	L mm	Ref	Price	Price
▶ 3000	910	713-3000	55,96 €	32,91 €
4000	900	713-4000	70,64 €	41,56 €
5000	900	713-5000	80,10 €	47,12 € ▶

HAMMER SHOVEL PICKS

FIBERGLASS HANDLE



g	L mm	Ref	Price	Price
▶ 700	380	715-700	38,12 €	22,41 € ▶

SPIKE SHOVEL PICK

FIBERGLASS HANDLE



g	L mm	Ref	Price	Price
▶ 400	330	719-400	34,38 €	20,22 €
650	325	719-650	37,08 €	21,81 € ▶

SLATE HAMMER



g	L mm	Ref	Price	Price
▶ 400	315	715-010	20,09 €	11,82 € ▶

PICK HEAD



g	Ref	Price	Price
▶ 2500	721-2500	32,72 €	19,15 €
3000	721-3000	37,82 €	22,13 € ▶

SPANISH STONE HAMMERS

FIBERGLASS HANDLE



g	L mm	Ref	Price	Price
▶ 1000	250	705-1000	28,51 €	16,76 €
1250	250	705-1250	31,72 €	18,66 € ▶

AXE SHOVEL PICK

FIBERGLASS HANDLE



g	L mm	Ref	Price	Price
▶ 550	385	717-550	30,76 €	18,09 €
650	325	717-650	34,79 €	20,47 € ▶

RUBBER HAMMERS

HICKORY HANDLE



g	Ø mm	L mm	Ref	Price	Price
685	60	330	736-685	14,89 €	8,76 €
920	65	340	736-920	18,12 €	10,66 € ▶

CHIPPING HAMMERS

TUBULAR HANDLE



g	L mm	Ref	Price	Price
▶ 500	300	715-001	19,37 €	11,40 € ▶

HICKORY

SPARE HANDLE



L mm	Ref	Price	Price
▶ 900	722H-900	12,51 €	7,32 € ▶

FIBERGLASS

SPARE HANDLE



L mm	Ref	Price	Price
▶ 900	723H-900	26,30 €	15,40 € ▶

PERCUSSION & CUTTING

AXE HICKORY HANDLE



g	L mm	Ref	Price	Price
▶ 500	450	724-500	26,89 €	15,82 €
700	445	724-700	29,10 €	17,12 €
1000	675	724-1000	39,62 €	23,31 € ▶

SLEDGE HAMMER AXE FIBERGLASS HANDLE



g	L mm	Ref	Price	Price
▶ 3000	920	726-3000	81,19 €	47,75 € ▶

SPLITTING WEDGE



g	Ref	Price	Price
▶ 1000	726-010	28,23 €	16,60 €
1500	726-015	30,33 €	17,84 €
2000	726-020	35,03 €	20,60 €
3000	726-030	47,88 €	28,15 € ▶

BOLT CUTTER WITH INTERCHANGEABLE BLADES

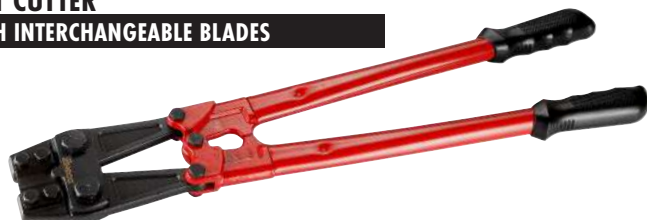

L mm	mm	Ref	Price	Price
▶ 600	5-10	292-060	168,59 €	99,16 €
900	8-16	292-090	204,74 €	120,44 € ▶

INTERCHANGEABLE BLADE

▶ Ref 292-069R
~~96,11 €~~ 56,53 €



- Three cut triangular blades
- Manufactured in high resistance alloy steel
- Fast blade replacement by the fixation bolts
- Cold redrawing tube arms
- Ergonomic handle

PROFESSIONAL BOLT CUTTER



L mm	mm	Ref	Price	Price
▶ 200	0,5~2	292-200	45,35 €	26,01 €
300	1~3,5	292-300	62,29 €	35,72 €
320	2~6,5	292-320	72,44 €	41,54 €
470	4~8	292-470	96,65 €	55,43 €
630	5~11	292-630	121,22 €	69,53 €
750	6~13	292-750	165,50 €	94,91 €
900	8~17	292-900	225,84 €	129,51 €
1050	9~19	292-1050	281,89 €	161,68 € ▶

DOUBLE LEVERAGE DIAGONAL CUTTING PLIER



Cutting Capacity	mm	Ref	Price	Price
▶ Piano Wire	3,8 mm	Ref 207-225	50,99 €	29,99 €
Steel Wire	6 mm ▶			

64 HRc

- Spring Joint. Automatic opening.
- Multiplies the Cutting Force with Less Effort

**STEEL INTERCHANGEABLE
HOLLOW PUNCH SET**

11
Pcs



Ref 940-320

940-03-20 Ø 2-20 mm



~~128,33 €~~ **75,49 €**

940-103 Ø 3
940-104 Ø 4
940-106 Ø 6

940-108 Ø 8
940-110 Ø 10



940-112 Ø 12
940-114 Ø 14
940-116 Ø 16

940-118 Ø 18
940-120 Ø 20



**BI-MATERIAL INTERCHANGEABLE
HOLLOW PUNCH SET**

16
Pcs



Ref 940-330

940-03-30 Ø 2-30 mm



~~257,25 €~~ **151,32 €**

940-103 Ø 3
940-104 Ø 4
940-106 Ø 6

940-108 Ø 8
940-110 Ø 10



940-112 Ø 12
940-114 Ø 14
940-116 Ø 16
940-118 Ø 18
940-120 Ø 20

940-122 Ø 22
940-124 Ø 24
940-126 Ø 26
940-128 Ø 28
940-130 Ø 30



**DRIFT PUNCH
SET**

**SHEATHED DRIFT PUNCH SET
"TOPGRIP" PATENTED HANDLE**

Ø 2 · 3 · 4 · 5 · 6 · 8 mm

TOPGRIP handle patented
Norm NFE 71211
DIN 6450C

Ref 7445-001

~~65,04 €~~ **38,25 €**

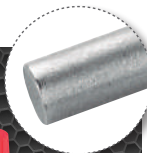

**DRIFT PUNCH SET
OCTAGONAL SHAPED BODY**

6
Pcs

Ø 3 · 4 · 5 · 6 · 8 · 10 mm

Ref 7446-003

~~49,15 €~~ **28,91 €**



**SHEATED DRIFT PUNCH
"SHOCKGRIP" PATENTED HANDLE**

Drift Punches manufactured to resist high impacts.
Patented Ergonomic ShockGrip Handle. Avoid Injuries.

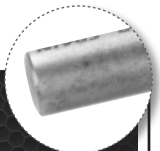

**SHEATED DRIFT PUNCH SET
"SHOCKGRIP" PATENTED HANDLE**

5

Pcs Ø 3 · 4 · 5 · 6 · 8 mm

Ref 7447-001

~~88,18 €~~ **51,87 €**



**SHEATED DRIFT PUNCH SET
"SHOCKGRIP" PATENTED HANDLE LONG SERIES**

4

Pcs Ø 10 · 12 · 14 · 16 mm

Ref 7447L-001

~~144,28 €~~ **84,88 €**



**AUTOMATIC
CENTRE PUNCH**

Cr-V 143 mm 36 kgs



Ref 750-013

~~38,45 €~~ **22,62 €**

• Maximum load: 36 kgs.

**HEXAGONAL STEEL
SCRIBER**



Ref 796-003

~~6,87 €~~ **4,04 €**

• Tungsten Carbide Tip

STD
HAND HACKSAW FRAME



L mm	Ref	Price
▶ 300	840-004	18,23 € 10,72 € ▶

Includes Bi-metal Blade
Suitable for 25 mm width blades

PROFESSIONAL
HAND HACKSAW FRAME

- Includes Bi-metal Blade
- Aluminium Shank
- 10 Blades Store
- 45° - 90° · Blade Clamping



L mm	Ref	Price
▶ 300	840-002	42,15 € 24,79 € ▶

BI-METAL
HAND HACKSAW BLADES

BI

		BI-METAL HSS EDGE	300 x 13 x 0,65 mm 12" x 1/2 x 0,025 in	Part N° 840-050	840-050
		BI-MET AL HSSCo 8%	300 x 13 x 0,65 mm 12" x 1/2 x 0,025 in	Part N° 840-059	840-059

L mm	A mm	B mm	Z	Box	Ref	Price
300	13	0,65	24	100	840-050	240,79 € 141,65 €
300	13	0,65	24	100	840-059	356,03 € 209,43 € ▶

2 BI-METAL
HAND HACKSAW BLADES SET



Ref	Price
Ref 840-070	2,83€ 1,66 €

2 BI-METAL
HAND HACKSAW BLADES SET



Ref	Price
Ref 840-067	6,02 € 3,51 €

PROFESSIONAL
PRUNING SAW



-
-

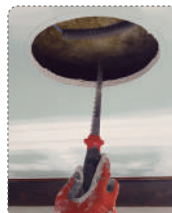

- Forefront end for frontal cutting
- Suitable for laminated plaster

L mm	Ref	Price
▶ 150	842-001	18,78 € 11,04 € ▶

PROFESSIONAL
FOLDING SAW



-

L mm	Ref	Price
▶ 190	843-001	26,88 € 15,81 € ▶

- Plasterboard & wood

ULTRA RESISTANCE CUTTER



- Extra long blade protection
- TPR Anti slip ergonomic handle
- Lock Force X5

A mm	L mm	Blade	Angle	Ref	Price
25	174	1	0,7	850-251	15,84 € 9,26 €



MULTI-FUNCTION SECURITY CUTTER

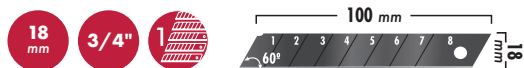

- Extra long blade protection.
- Anti slip ergonomic handle with anti-drop.
- Two spare blades store.

A mm	L mm	Blade	Angle	Ref	Price
18	190	1	0,5	850-181	14,98 € 8,76 €



MULTI-FUNCTION CUTTER



- Stainless steel tip. Maximum durability.
- Double guide blade clamping.
- Ergonomic, soft touch, bi material and aluminium handle.
- Anti-drop.

A mm	L mm	Blade	Angle	Ref	Price
18	160	1	0,5	850-180	15,71 € 9,19 €

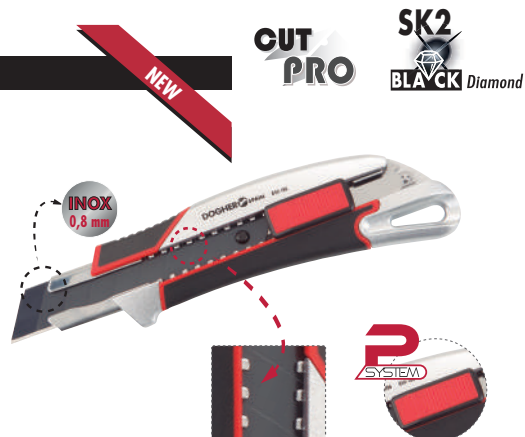

SCREW LOCKING KNIFE CUTTER

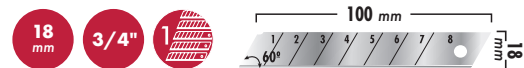

- Spare blade store.

A mm	L mm	Blade	Angle	Ref	Price
18	160	1	0,5	789-001	5,68 € 3,34 €



NYLON BAG FOR KNIFE CUTTER

A mm	Ref	Price
18	789V-18	11,73 € 6,87 €



SECURITY CUTTER



- Safer rounded corners
- Security system, blade self retractable.
- Stainless steel tip. Maximum durability.
- Soft touch, ergonomic handle with anti-drop.

A mm	L mm			Ref	11,63 €	6,81 €
19	155	1	0,6	850-005		

INOX 1 mm



CUT PRO SK2 Long Life



P SYSTEM CUTTER



- Anti slip ergonomic handle with anti-drop.
- Extra long blade protection

A mm	L mm			Ref	7,72 €	4,51 €
9	153	1	0,4	850-091		



CUT PRO SK2 BLACK Diamond



SCRAPER



- Blade protector.
- Anti slip ergonomic handle.

A mm	L mm			Ref	41,95 €	24,56 €
17,5	380	1	0,36	887-010		



QUICK CHANGE

PROFESSIONAL SCRAPER

- Carbide blade
- 360° adjust knob
- Removes easily paint, glue, varnish and oxides.
- 360° adjust knob to proceed with different angles.
- Anti-slip ergonomic bi-material handle.



60 mm	Ref 887-001	31,01 €	18,24 €
-------	-------------	--------------------	---------



PUTTY KNIFE BIMATERIAL HANDLE RIGID BLADE

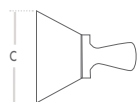

Inox



C mm	Ref	21,12 €	12,43 €
152	881-PH2		

PUTTY KNIFE BIMATERIAL RIGID BLADE



Inox



C mm	Ref	6,11 €	3,59 €
30	879-30		
40	879-40	6,16 €	3,62 €
50	879-50	6,46 €	3,79 €
60	879-60	6,75 €	3,97 €
70	879-70	7,22 €	4,24 €
80	879-80	7,74 €	4,56 €
100	879-100	8,64 €	5,09 €
120	879-120	9,93 €	5,84 €
150	879-150	11,91 €	7,00 €

BUCKET TROWEL
BIMATERIAL HANDLE

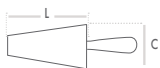

	C mm	L mm	Ref	
▶ A	115	180	883-02-180	15,73 € 9,25 € ▶

MADRID MODEL TROWEL
BIMATERIAL HANDLE



	C mm	L mm	Ref	
▶ F-H	98	178	883-04-180	14,31 € 8,41 € ▶

CATALAN MODEL TROWEL
BIMATERIAL HANDLE



	C mm	L mm	Ref	
▶ B	120	170	883-06-170	15,08 € 8,87 € ▶

CHALK LINE WITH DEPOSIT
FOR CHALK POWDER



	Ref	
▶ 30	798-001	12,79 € 7,53 € ▶



PLASTERING TROWEL
WOODEN HANDLE

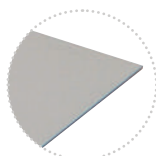

	C mm	L mm	Ref	
▶ 01	150	300	886-002	15,31 € 9,00 € ▶

ADHESIVE TROWEL
WOODEN HANDLE



6x6 mm



	C mm	L mm	Ref	
▶ 06	120	280	886-005	16,78 € 9,87 € ▶

ADHESIVE TROWEL
WOODEN HANDLE



8x8 mm



	C mm	L mm	Ref	
▶ 08	120	280	886-006	16,29 € 9,59 € ▶

ADHESIVE TROWEL
WOODEN HANDLE



10x10 mm



	C mm	L mm	Ref	
▶ 10	120	280	886-007	17,21 € 10,12 € ▶

LOW DENSITY
SPONGE FLOAT

- Low Density Foam
- 30mm Thick Sponge Base

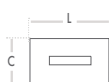

	C mm	L mm	Ref	
▶ 140	280	886-018	13,68 € 8,04 € ▶	

RECTANGULAR
PLASTIC FLOAT

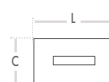

	C mm	L mm	Ref	
▶ 180	270	886-013	7,24 € 4,25 € ▶	

FOAM RUBBER SPONGE FLOAT

- 20mm Thick Sponge Base
- Polystyrene Handle and Base
- Diameter of holes bigger than Ref.886-017

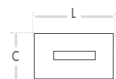
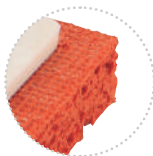

C mm	L mm	Ref		
▶ 140	280	886-016	17,06 €	10,03 € ▶

HIGH DENSITY FOAM RUBBER SPONGE FLOAT

- 20mm Thick Sponge Base
- Polystyrene Handle and Base
- Diameter of holes smaller than Ref.886-016

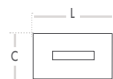
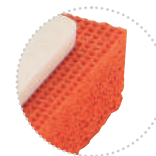

C mm	L mm	Ref		
▶ 140	280	886-017	17,45 €	10,26 € ▶

RECTANGULAR SCRAPER



g	A mm	B mm	Ref		
▶ 1400	310	130	876-010	25,64 €	15,09 € ▶

HALF ROUND SCRAPER

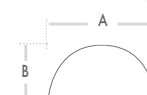

g	A mm	B mm	Ref		
▶ 1200	270	160	876-020	22,84 €	13,44 € ▶

RAKE HEAD



N°	g	A mm	B mm	Ref		
▶ 12	575	350	95	874-012	13,32 €	7,79 €
14	670	410	95	874-014	14,06 €	8,24 €
16	776	475	95	874-016	14,82 €	8,68 € ▶

SPARE HANDLE FOR RAKE



L mm	Ref		
▶ 1200	874-001	11,66 €	6,82 € ▶

WRECKING BAR



L mm	mm	Ref		
▶ 300	14	884-04-300	14,59 €	8,57 €
500	20	884-05-500	21,57 €	12,69 €
600	20	884-05-600	27,73 €	16,31 €
700	20	884-05-700	31,52 €	18,54 €
800	22	884-05-800	34,98 €	20,57 €
900	22	884-05-900	40,82 €	24,00 €
1000	22	884-05-1000	45,17 €	26,56 €
1200	22	884-05-1200	50,92 €	29,96 € ▶

PAINT PADDLE MIXER



- Mixer Rod range for low density materials as paint among others.
- Hexagonal Rod for drilling machine attachment

L mm	Ø mm	Hex	g	Ref		
400	80	7,8	245	890-010	16,17 €	9,47 €
600	100	9,5	500	890-011	17,34 €	10,15 € ▶

MORTAR PADDLE MIXER



- Mixer Rod range for high density materials as mortar among others.
- Mixer Rod connection with M14 thread.

L mm	Ø mm	Hex	g	Ref		
600	100	14	660	890-020	24,76 €	14,49 €
600	120	14	1004	890-022	27,69 €	16,21 €
600	140	14	1110	890-024	31,12 €	18,22 € ▶

WOODEN HANDLE SHOVELS

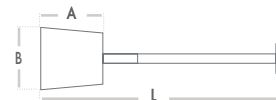

T HANDLE POINTED SHOVEL



g	A mm	B mm	L mm	Ref	
2000	340	280	1020	870-010	29,83 € 17,54 €

T HANDLE SQUARE SHOVEL



g	A mm	B mm	L mm	Ref	
2000	340	280	1020	870-020	29,83 € 17,54 €

RING HANDLE POINTED SHOVEL



g	A mm	B mm	L mm	Ref	
2000	340	280	1020	870-030	33,49 € 19,69 €

RING HANDLE SQUARE SHOVEL



g	A mm	B mm	L mm	Ref	
2000	340	280	1020	870-040	34,09 € 20,04 €

ALUMINIUM & PLASTIC SHOVELS

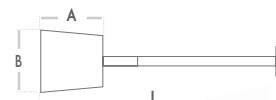

RING HANDLE ALUMINIUM SHOVEL



g	A mm	B mm	L mm	Ref	
1500	390	315	1130	871-010	50,35 € 29,62 €

RING HANDLE ALUMINIUM SHOVEL



g	A mm	B mm	L mm	Ref	
1000	305	245	1020	871-030	37,54 € 22,07 €

D-HANDLE PLASTIC SHOVEL



g	A mm	B mm	L mm	Ref	
1600	460	360	1250	871-050	44,34 € 26,07 €

RING HANDLE SQUARE SHOVEL



g	A mm	B mm	L mm	Ref	
1800	295	225	1010	870-041	35,23 € 20,72 €

CAULKING GUNS

FOAM GUN

PRO

- Fully Teflon coated
- Ergonomic bimaterial handle
- Aluminum adapter for fast & firm use
- Aluminum adapter for fast & firm
- Brass gasket nut and aluminium regulation wheel
- Easy to clean, heavy duty use



L mm	L2 mm	Ø mm	Ø2 mm	Ref	
▶ 325	190	11	14	914-001	41,63 € 24,49 € ▶

CAULKING GUN

4000 NW
25:1
360°



L mm	Ø mm	Ref	
▶ 225	55	917-225	37,13 € 21,74 € ▶

CAULKING GUN FAST RECOIL

Ø mm 55
360°
1500 NW
XTREME



ANTI-DRIP

L mm	Ø mm	Ref	
▶ 225	55	916-225	22,28 € 13,10 € ▶

CAULKING GUN WITH SPOUT CUTTER

Ø mm 57
360°
1500 NW
XTREME



L mm	Ø mm	Ref	
▶ 225	57	915-225	24,53 € 14,43 € ▶

TRIPLE BARREL CAULKING GUN

Ø mm 78
1500 NW
XTREME



L mm	Ø mm	Ref	
▶ 225	78	914-225	35,03 € 20,60 € ▶

FAST RECOIL CAULKING GUN

Ø mm 55



L mm	Ø mm	Ref	
▶ 225	55	912-225	21,89 € 12,88 € ▶

MORTAR CAULKING GUN ALUMINIUM BODY

Ø mm 50



L mm	Ø mm	Ref	
▶ 375	50	913-375	29,58 € 17,40 € ▶

DOUBLE SOCKET SCAFFOLDING WRENCH

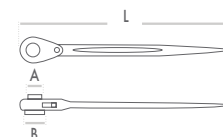

CrV	A mm	B mm	L mm	Ref	
▶	19	22	320	892-19-22	48,55 € 28,54 € ▶

ONE HANDED BAR CLAMP

16x5
wheel  120
Kg 



L mm	Ref	Price	Price
▶ 150	855-150	24,77 €	14,57 €
300	855-300	27,26 €	16,03 €
450	855-450	29,68 €	17,46 €
600	855-600	39,15 €	23,03 € ▶

KNEE BLADES WITH 5 WHEELS

- Structure manufactured in high resistance polyethylene.
- 50mm diameter and 17mm wide wheels
- Knee protectors made of high density foam including:
 - Front holder for tools
 - Central magnetized holder for tools
- Suitable for any kind of workshop and works on the flooring such as cleaning, parquet and tiling installation...



▶ ~~94,00 €~~ **55,29 €**
525 x 255 x 90 mm

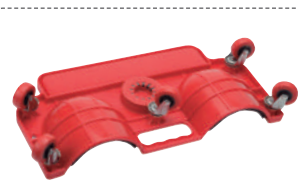

SUCTION CUPS



Ø mm	Capacity	Ref	Price	Price
▶ 115	50 kg	945-001	19,41 €	11,41 € ▶

- Aluminium structure.
- One-handed use.
- Automotive and transport applications.
- To be used in smooth and non-porous surfaces.



Ø mm	Capacity	Ref	Price	Price
▶ 115	100 kg	945-002	38,82 €	22,84 € ▶

- Aluminium structure Double.
- Automotive and transport applications.
- To be used in smooth and non-porous surfaces.



Ø mm	Capacity	Ref	Price	Price
▶ 115	130 kg	945-003	53,70 €	31,59 € ▶

- Aluminium structure Triple.
- Automotive and transport applications.
- To be used in smooth and non-porous surfaces.



Ø mm	Capacity	Ref	Price	Price
▶ 203	180 kg	945-004	102,25 €	60,15 € ▶

- High resistance suction cups including a priming pump.
- Vacuum monitored through the pressure gauge
- Valve to release pressure.
- For curved and structured surfaces.

WINDSHIELD SUCTION CUPS



Ø mm	Capacity	Ref	Price	Price
▶ 118	80 kg	945-005	46,60 €	27,41 € ▶

- Two plates structure
- Articulated handle, it allows the adjustment to curved surfaces
- Special for car maintenance, installing and uninstalling of car sheets and windshields

Ø mm	Capacity	Ref	Price	Price
▶ 230	200 kg	945-006	176,94 €	104,07 € ▶

- One plate structure
- Special for curved surfaces mainly windshields

PRUNERS



HEAVY DUTY PRUNER



- High resistance CK67 upper and lower blade with **Teflon** coating.
- Aluminium alloy handle with PVC dipping
- Security lock.

	L mm	Ref	
▶ 15	210	960-003	27,65 € 16,26 € ▶

FILES

BI-MATERIAL HANDLE 3 FILE SET

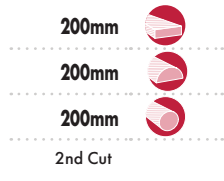

▶	Ref 815-001
37,66 €	22,15 €



Includes Canvas Wallet

BI-MATERIAL HANDLE POINTED FLAT FILE SECOND CUT

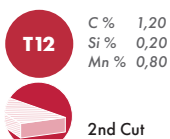
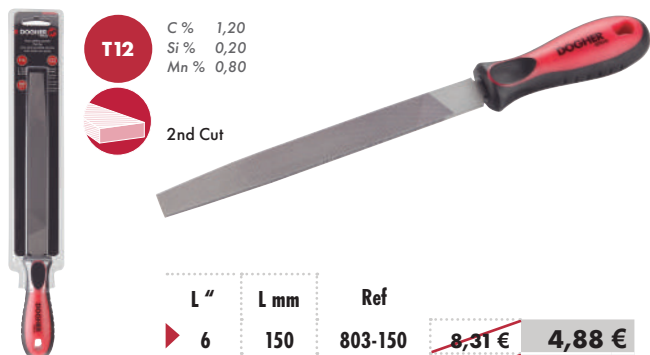

	L "	L mm	Ref	
▶	6	150	803-150	8,31 € 4,88 €
	8	200	803-200	10,68 € 6,28 €
	10	250	803-250	12,79 € 7,53 €
	12	300	803-300	16,07 € 9,46 € ▶

BI-MATERIAL HANDLE FLAT FILE BASTARD CUT

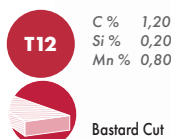
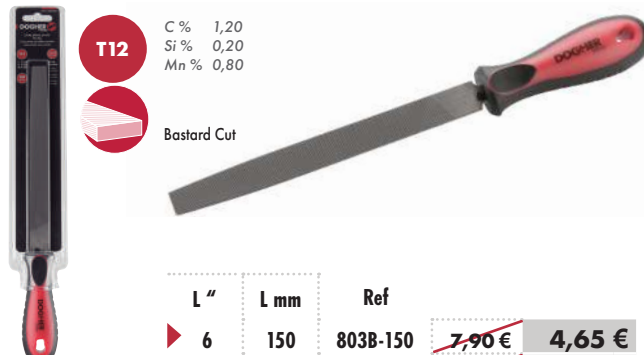

	L "	L mm	Ref	
▶	6	150	803B-150	7,90 € 4,65 €
	8	200	803B-200	9,68 € 5,69 €
	10	250	803B-250	12,15 € 7,13 €
	12	300	803B-300	15,27 € 8,99 € ▶

10 DIAMOND PRECISION FILES SET

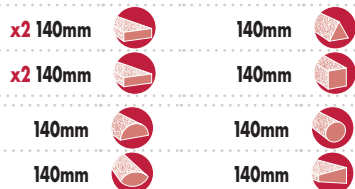

▶	Ref 816-001
138,98 €	81,75 €

THREAD RESTORING FILE

- For external and internal threads
- Metric pitches: 0,80-1,00-1,25-1,50-1,75-2,00-2,50-3,00



	▶	Ref 817-010
	71,27 €	41,93 €

MULTIPLE 2 & 3 ARMS

GEAR PULLER

- 100 mm** CrV
- 200 mm**
- 250 mm**

L mm	A min-A max	B min-B max	Ref
▶ 100-250	30-140	55-170	905-004

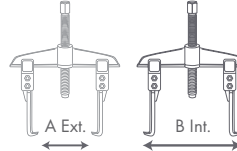

~~458,81 €~~ **269,88 €**

SEPARATOR PULLER

TOOLS SET

- CrV
- 30-50 mm
- 50-75 mm

min-max	Ref
▶ 30-75	905-005

~~266,29 €~~ **156,63 €**



RIVET GUN

PROFESSIONAL RIVET GUN

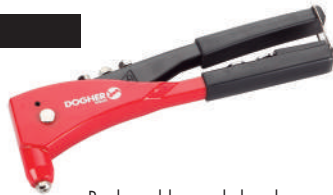

Ref 918-010
~~41,78 €~~ **24,57 €**

- Replaceable nozzle head
- 4 heads are included ø 2,4-3,2-4-4,8 mm.
- Spring loaded handle ejects rivets stem
- Comfortable anti slip handle

AUTOMATIC RIVET GUN



4 in 1

Ref 918-012
~~36,42 €~~ **21,43 €**

- Replaceable nozzle head
- 4 heads are included ø 2,4-3,2-4-4,8 mm.
- Spring loaded handle ejects rivets stem
- Comfortable anti slip handle

TWO HANDS RIVET

- Hard Metal Clamps
- Internal Force Multiplier
- Ergonomic Handle
- Aluminium Body
- for Ø 2,4-3,2-4-4,8-6,4 mm rivets
- Ø 2,4-3,2-4-4,8 mm Stainless Steel rivets

Ref 919-016
~~77,09 €~~ **45,35 €**



XTREME



MULTIFUNCTION HAND RIVET GUN

3 in 1

XTREME

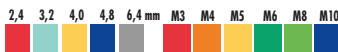

Ref 919-020
~~148,76 €~~ **87,50 €**

HAND NUT RIVETER



- Special for intensive works.
- Ergonomic hand nut riveter gun for reduced effort.
- Easy components replacement.
- Includes multifunctional key

▶ **410 mm** Ref 919-025
~~124,20 €~~ **73,06 €**

**OIL FILTER BELT
WRENCH**



mm	Ref	26,66 €	15,68 €
▶ 65~105	481-65-105		
110~165	481-110-165	28,32 €	16,66 € ▶

• Remove the screw at the rotary rear end to replace the band.

**CHAIN OIL FILTER
WRENCH**



L mm (Chain)	Ø mm	Ref	56,95 €	33,49 €
▶ 350	60-105	481-010		
520	60-160	481-011	84,71 €	49,82 € ▶

**BELT OIL FILTER
WRENCH**



L mm (Belt)	Ø mm	Ref	36,30 €	21,34 €
▶ 580	60-140	481-020		
840	60-265	481-021	67,29 €	39,59 € ▶

30 PIECES

OIL FILTER CAP SET

Includes:

- 28 press-on sleeve
- 3 Claw Adjustable Oil Filter Wrench 65-120mm
- 1 Reduction adaptor 1/2" to 3/8"

▶ Ref 481-001
~~211,74 €~~ 124,54 €



11 PIECES

TRIM REMOVAL TOOLS SET



- Auto repair tools for dismantling panels, dashboards, mouldings, boards and other accessories from the vehicle interior.
- Manufactured in high resistance plastic to guarantee a long durability.
- Soft but resistant material avoids sensitive pieces and surfaces to get damaged



▶ Ref 480-011
~~42,26 €~~ 24,74 €

UNIVERSAL HOSE CLAMP REMOVER

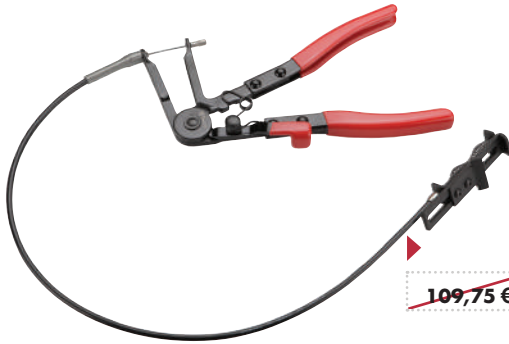

600 mm

Ref 2200-005

~~109,75 €~~ 64,56 €

- Cable length 600 mm
- Retention trigger keeps hose clamp open for an easy installation or removal, even in places with limited access.
- Long reach plier to remove or lock open hose clamps in hidden areas and long distance.
- Suitable for hose clamps on fuel, oil and water hose.
- Working range: 10-63 mm
- Practical lock system for free hand works.

HOSE PINCHING PLIER



L mm	Ref	Price	Price
155	2200-010	9,97 €	5,85 €
185	2200-011	12,43 €	7,31 €
250	2200-012	16,97 €	9,97 €

- Suitable to pinch flexible hoses off.
- Applications: Fuel supplying chains, heaters, cooling systems, radiators, brakes,...
- Practical jaws adjusting system for one handed use.

HOSE CLAMP PLIER



215 mm

8,5"



Ref 2200-20

~~49,07 €~~ 28,87 €

- Slotted & swivel jaws for positive holding of both large and small hose clamps at any angle.
- Made of high performance alloy steel.
- Maximum jaws opening: 45 mm
- Ratchet action keeps jaws closed in 5 different positions.

45° ANGLE HOSE CLAMP PLIER



190 mm

7,5"



Ref 2200-25

~~51,29 €~~ 30,18 €

- Suitable for releasing and refitting reusable CLIC and CLIC-R hose clips.
- 45° offset execution allows easier work in limited access places.
- Flexible heads allow easier work in limited access places.
- Angled head and 360° flexible jaws.
- Non-slip red dipped PVC handle.
- Compatible with:
Volkswagen · Audi · Citroën · Peugeot · Fiat · Mercedes · Opel · Renault

AUTOMATIC HOSE CLAMP PLIER



275 mm

10,8"



Ref 2200-30

~~129,74 €~~ 76,32 €

- For spring loaded clamps with flat norma and muhr and bender section used on refrigeration circuit sleeves.
- V shaped jaws make hose clamp installation easier.
- Maximum jaws opening: 12-55 mm
- Safety lock.
- PVC handle.

PSA EXHAUST CLAMP PLIER



306
mm

12"



Ref 2200-35

~~67,29 €~~ 39,59 €

- This plier keeps spring loaded clamps open when the leakage must be repaired
- Maximum jaws opening: 55 mm
- Made of high performance alloy steel.
- Ratchet action keeps jaws closed in 8 different positions.
- Non-slip red dipped PVC handle.

WHEEL BALANCING PLIER



240
mm

9.1/2"



Ref 2200-40

~~25,24 €~~ 14,84 €

- Plier used to remove wheel balancing weights.
- To tighten and loose spring loaded clamps
- To loose, cut and fix balancing weights.
- Blade makes possible to split balancing weights.
- Made of high performance alloy steel.
- Non-slip red dipped PVC handle.

BOTTLE JACK

WELDED BOTTLE JACK



• Release valve.



• Serrated heat-treated saddle with adjustment screw for an improved versatility.



• Pump plunger.

HIDRA PRO

• Made in high quality steel according to the highest standards of quality and durability

• The paint is resistant to oil, grease and dirt for an easy cleaning.



• Telescopic bar.



Capacity	Min. Height	Elevation Height	Adjustable Height	Max. Height	N.W. kg.	Ref	
▶ 02 TON	168 mm	100 mm	48 mm	316 mm	2 kg	9000-02	55,90 € 32,88 €
05 TON	207 mm	127 mm	60 mm	404 mm	3,7 kg	9000-05	73,70 € 43,35 €
10 TON	222 mm	145 mm	80 mm	447 mm	4,7 kg	9000-10	95,83 € 56,37 € ▶

• Made in high quality steel according to the highest standards of quality and durability

• The paint is resistant to oil, grease and dirt for an easy cleaning.

• Steel handle for an easier transport of the jack



• Telescopic bar

Capacity	Min. Height	Elevation Height	Adjustable Height	Max. Height	N.W. kg.	Ref	
▶ 15 TON	227 mm	150 mm	80 mm	457 mm	6,9 kg	9000-15	128,99 € 75,87 €
20 TON	225 mm	150 mm	60 mm	445 mm	8,8 kg	9000-20	160,69 € 94,51 €
32 TON	260 mm	160 mm	-	420 mm	17,8 kg	9000-32	243,56 € 143,28 € ▶

FLOOR HYDRAULIC JACKS

LOW PROFILE HYDRAULIC GARAGE JACK



• Rear casters to scroll more easily



• Low profile design easy to get under most of the vehicles.



• Double front casters

HIDRA PRO



Capacity	Min. Height	Lifting Height	N.W. kg.	Dimensions mm	Ref	
▶ 2 TON	80 mm	510 mm	43 kg	822x360x214	9010-02	787,27 € 463,10 € ▶ CE



• Rotating rear wheels to scroll more easily



• 360° swivel positive locking safety release handle



• 360° rotating saddle to improve its versatility

Capacity	Min. Height	Lifting Height	N.W. kg.	Dimensions mm	Ref	
▶ 2 TON	89 mm	359 mm	14,2 kg	556x234x140	9015-02	204,36 € 120,21 € TUV GS CE



• Release valve

HYDRAULIC GARAGE JACK



• Rotating rear wheels to scroll more easily



• 360° swivel positive locking safety release handle

Capacity	Min. Height	Lifting Height	N.W. kg.	Dimensions mm	Ref	
▶ 2 TON	135 mm	340 mm	8,7 kg	447x196x135	9025-02	144,80 € 85,18 €

Capacity	Min. Height	Lifting Height	N.W. kg.	Dimensions mm	Ref	
▶ 3 TON	135 mm	400 mm	16,7 kg	520x195x135	9025-03	215,39 € 126,69 €



• High resistance steel castors

HYDRAULIC ENGINE CRANE FOLDABLE

- Tool designed to lift, low and move engines, differentials and other heavy loads with a minimum effort.
- Reliability and security of the product have been tested.
- Below structure provided with castors to ensure more stability and movement.
- Adjustable lifting arm.
- Structure in tubular heavy gauge steel.
- Can be folded for an easy storage.



• 4 positions

• 2 rotating wheels



• 4 rotating wheels

Capacity	Min. Height A	Lifting Height B	Length max. C	Width max. D	N.W. kg.	Ref	
▶ 1 TON	25 mm	2.040 mm	1.510 mm	1.015 mm	65 kg	9030-01	661,89 € 389,35 € ▶ TUV GS

Capacity	Min. Height A	Lifting Height B	Length max. C	Width max. D	N.W. kg.	Ref	
▶ 2 TON	25 mm	2.445 mm	1.740 mm	1.040 mm	110 kg	9030-02	1.233,62 € 725,68 € TUV GS CE

TRANSMISSION

JACKS

- For use in pits and underneath elevated vehicles.
- The lifting and lowering of the load using the foot pedal allow the hands to be free for other jobs.
- Easily manoeuvrable thanks to the four swivel castors.
- The large base size provides high stability under load.



• Valve



• The large base size provides high stability under load.



• 4 High-strength steel rotating wheels 360° facilitate the movement.

Capacity	Min. Height	Lifting Height	N.W. kg.	Ref	CE
▶ 0,5TON	1.140 mm	1.945 mm	24 kg	9040-0,5	490,41 € 288,47 €



• Valve



• The lifting and lowering of the load using the foot pedal allow the hands to be free for other jobs.



• The large base size provides high stability under load.



• 4 High-strength PA rotating wheels 360° facilitate the movement.

Capacity	Min. Height	Lifting Height	N.W. kg.	Ref	CE
▶ 1,5TON	1.130 mm	1.915 mm	24 kg	9040-1,5	1.019,14 € 599,50 €



- Frame is constructed in high-grade steel according to the highest standards of quality and durability.
- Paint is oil, grease and dirt-resistant for easy cleanup.

- Lead-free paint finish is applied after a thorough chemical wash to ensure a long-lasting finish and to help prevent rust.



- Frame is constructed in high-grade steel according to the highest standards of quality and durability.

- Paint is oil, grease and dirt-resistant for easy cleanup.

- Lead-free paint finish is applied after a thorough chemical wash to ensure a long-lasting finish and to help prevent rust.

LOCKING

JACK STANDS

- Locking Jack stand is the perfect complement to other car jacks as an essential security measure. Great stability and wide stable support feet.
- Angled teeth in post prevent accidental release of load – the more weight applied, the tighter the post is locked.



• The large surface area provides better contact with the supported load.



• Angled teeth in post to provide maximum security.



• Equipped with a double-lock protection feature.

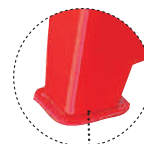

• The wide base prevents from the sinking into the asphalt and similar surfaces.

- Built in high-resistance cast iron

- Paint is oil, grease and dirt-resistant for easy cleanup

- Structure is made in high-resistance welded steel.



Capacity	Min. Height	Lifting Height	N.W. kg.	Ref	CE	GS	€/2u.
▶ 2TON	278 mm	428 mm	5 kg	9050-02	71,40 €		42,00 €
▶ 3TON	288 mm	428 mm	6,6 kg	9050-03	75,60 €		44,47 €
▶ 6TON	395 mm	613 mm	12,9 kg	9050-06	166,21 €		97,76 €

Capacity	Min. Height	Lifting Height	N.W. kg.	Ref	CE	GS	€/2u.
▶ 10TON	468 mm	718 mm	27,8 kg	9050-10	277,50 €		163,24 €



**TOOL CABINET
7 DRAWERS**



Monza

Ref 025-014
~~1.318,85 €~~ **775,81 €**

**TOOL CABINET
6 DRAWERS**



Silverstone

Ref 025-015
~~1.277,23 €~~ **751,31 €**

**TOOL CABINET
5 DRAWERS**



Suzuka

Ref 025-016
~~1.198,97 €~~ **705,28 €**

Dimensions F1 range

Tool Cabinet: 678 x 459 x 1.000 mm

Drawers: 568 x 398 x 75 mm · 568 x 398 x 154 mm



Fast Lock/Unlock function drawers



Safety central locking



Long life casters and safety brakes



Reinforced Plastic Protection Around the Edges



10 x 10 mm

38 x 38 mm Perforated side pannel



Max. Load per drawer: 40 - 45 Kg

**TOOL CABINET
7 DRAWERS**



Jerez

Ref 025-017
~~1.194,65 €~~ **702,74 €**

**TOOL CABINET
6 DRAWERS**



Sepang

Ref 025-019
~~1.149,80 €~~ **676,34 €**

Dimensions GP range

Tool Cabinet: 678 x 459 x 1.000 mm

Drawers: 568 x 398 x 75 mm · 568 x 398 x 154 mm



Fast lock/Unlock function drawers



Safety central locking



Long life casters and safety brakes



Reinforced plastic protection around the edges

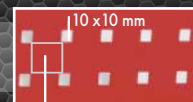

38 x 38 mm Perforated side pannel



Max. Load per drawer: 30 - 35 Kg

std

Dimensions STD range

Tool Cabinet: 678 x 459 x 1.000 mm

Drawers: 568 x 398 x 75 mm • 568 x 398 x 154 mm



Side metal handle for easy transport



Safety central locking



Long life casters and safety brakes



Max. Load per drawer: 30 - 35 Kg
Max Load for Tool Cabinet: 320 Kg

Tool Cabinets Features

std

STORAGE

TOOL CABINET 7 DRAWERS



Ref 025-005

~~1.038,36 €~~ 610,79 €

TOOL CABINET 6 DRAWERS



Ref 025-006

~~930,63 €~~ 547,43 €

TOOL CABINET 5 DRAWERS



Ref 025-007

~~827,53 €~~ 486,78 €

TOOL CABINET 3 DRAWERS



680 x 458 x 995 mm

Ref 025-008

~~909,07 €~~ 534,76 €

6 DRAWER TOOL CABINET SF SYSTEM



Anti-tilt Security system

NEW



Ref 025-206

~~957,86 €~~ 560,63 €



SYSTEM

by DOGHER TOOLS



SAFETY SYSTEM

• anti-tilt security system that allows opening a single drawer at a time.

COMPOSITION +211 TOOLS

TOOL CABINET +211 TOOLS

Silverstone



Ref 025-015

Ref 025-563

~~2.338,51 €~~ 1.375,60€



TOOL CABINET +211 TOOLS

Sepang



Ref 025-019

Ref 025-560

~~2.211,08 €~~ 1.300,63 €



TOOL CABINET +211 TOOLS

std

Ref 025-006

Ref 025-569

~~1.991,90 €~~ 1.171,71 €



205-080 • 330-080 • 451-080 • 450-080



Eva Foam Trays 1/4

(375 x 140 x 30 mm) Content:

- ▶ Ref 205-080: 4 Professional Pliers
- ▶ Ref 330-080: 5 Professional Screwdrivers
- ▶ Ref 451-080: 8 Combination Wrenches
- ▶ Ref 450-080: 8 Double Open Ended Wrenches

840-080



Eva Foam Trays 1

(375 x 560 x 30 mm) Content:

- ▶ Ref 840-080: Multitools

500-084

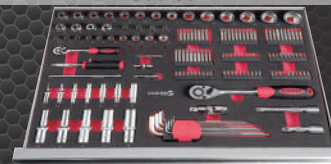

Eva Foam Trays 1

(375 x 560 x 30 mm) Content:

- ▶ Ref 500-084: Multitools

DOGHER TOOLS

55

SERVICE CHART
3 FLOORS



Ref 025-028
~~301,25 €~~ 177,21 €

SERVICE CHART
3 FLOORS & 1 DRAWER



Includes a Drawer
~~369,85 €~~ 217,56 €

INOX
SERIES

5 & 7 DRAWER
TOOL CABINET



Aisi 304

460 mm
846 mm
680 mm



Ref 20025-007

~~2.109,69 €~~ 1.520,22€

• Drawer Dim.:
568 x 398 mm

500 mm
998 mm
760 mm



Ref 20025-005

~~2.442,26 €~~ 1.759,87€

• Drawer Dim.:
644 x 399 mm

DRAWER COMPOSITIONS
FOR TOOL CABINETS



DESCRIPTIVE INK PRINTING FOR A QUICK SEARCH
HIGH DENSITY FOAM FOR AN EASY PLACEMENT OF THE TOOLS

238 SELECTED TOOLS
ASSORTMENT OF 6 DRAWERS

Ref 025-504
~~3.253,91 €~~ 1.866,22 €

* Tool Cabinet not included

► DRAWER 1

220X-080 • 205-080 • 225-080 • 276-080

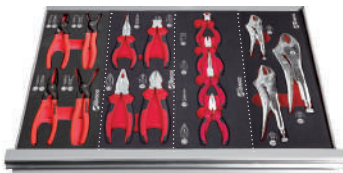

► DRAWER 2

300-081 • 330-081 • 351-081 • 360-080



► DRAWER 3

450-080 • 451-080 • 460-080 • 491-080

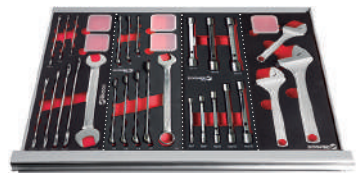

► DRAWER 4

840-080



► DRAWER 5

501-080 • 618-080



► DRAWER 6

534-080 • 538-080 • 502-080 • 503-080



* Check contents of EVA Foam Trays in DOGHER TOOLS Promotion from page 57 to page 63.

4 HIGH LEVERAGE

PLIERS



160 mm 200 mm



180 mm 160 mm

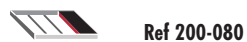

~~154,28 €~~ 90,76 €



1

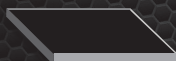

Dimensions 1:
375 x 560 x 30 mm

1/2



Dimensions 1/2:
375 x 280 x 30 mm

1/3



Dimensions 1/3:
375 x 188 x 30 mm

1/4



Dimensions 1/4:
375 x 140 x 30 mm

EVA FOAM TRAYS FOR TOOL CABINETS



4 PROFESSIONAL

PLIERS



160 mm 160 mm



180 mm 180 mm



~~99,29 €~~ 58,40 €



4 CIRCLIP®

PLIERS



180 mm 180 mm



180 mm 180 mm



~~79,53 €~~ 46,78 €



4 CIRCLIP®

PLIERS PRO



180 mm 180 mm



180 mm 180 mm



~~125,24 €~~ 73,66 €



3 INSULATED

PLIERS 1000V



160 mm



180 mm 160 mm



~~126,71 €~~ 74,53 €



4 PROFESSIONAL

MINI-PLIERS



125 mm 125 mm



125 mm 125 mm



~~78,65 €~~ 46,26 €



4 ESD

MINI-PLIERS



125 mm 125 mm



125 mm 125 mm



~~91,65 €~~ 53,90 €



8 DOUBLE OPEN ENDED

WRENCHES



6x7 · 8x9 · 10x11 · 12x13

14x15 · 16x17 · 18x19 · 20x22



~~80,05 €~~ 47,09 €



8 COMBINATION

WRENCHES



8 · 10 · 11 · 12 · 13 · 14 · 17 · 19



~~90,54 €~~ 53,26 €



8 DOUBLE RING FLAT

WRENCHES



6x7 · 8x9 · 10x11 · 12x13

14x15 · 16x17 · 18x19 · 20x22



~~116,63 €~~ 68,60 €



8 DOUBLE ENDED HEX SOCKET

WRENCHES



6x7 · 8x9 · 10x11 · 12x13

14x15 · 16x17 · 18x19 · 20x22



~~181,03 €~~ 106,49 €



3 SPANISH ADJUSTABLE

WRENCHES



150mm · 200mm · 250mm

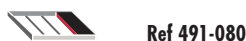

~~125,50 €~~ 73,82 €



3 PROFESSIONAL ADJUSTABLE

WRENCHES



150mm · 200mm · 250mm



~~94,55 €~~ 55,62 €



EVA FOAM TRAYS FOR TOOL CABINETS



6 INDUSTRIAL PLUS SCREWDRIVERS

- Milled 3 · 4 · 5 · 6
- PH1 · PH2

Ref 300-080
~~65,26 €~~ **38,38 €**

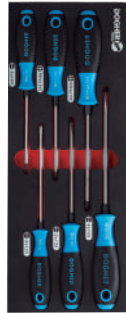

6 INDUSTRIAL PLUS SCREWDRIVERS

- Milled 3 · 4 · 5 · 6
- PZ1 · PZ2

Ref 300-081
~~65,26 €~~ **38,38 €**



6 INDUSTRIAL PLUS SCREWDRIVERS

- T10 · T15 · T20
- T25 · T30 · T40

Ref 303-080
~~59,61 €~~ **35,07 €**



5 INDUSTRIAL SCREWDRIVERS

- Milled 5,5 · 6,5
- PH1 · PH2 · PH3

Ref 315-080
~~53,05 €~~ **31,21 €**



5 INDUSTRIAL SCREWDRIVERS

- Milled 5,5 · 6,5
- PZ1 · PZ2 · PZ3

Ref 315-081
~~51,96 €~~ **30,57 €**



5 PROFESSIONAL SCREWDRIVERS

- Stamped 5,5 · 6,5
- PH1 · PH2 · PH3

Ref 330-080
~~46,13 €~~ **27,13 €**

- Stamped 4 · 5,5
- PH1 · PH2 · PH3

Ref 330-085
~~44,09 €~~ **25,93 €**



5 PROFESSIONAL SCREWDRIVERS

- Stamped 5,5 · 6,5
- PZ1 · PZ2 · PZ3

Ref 330-081
~~47,88 €~~ **28,16 €**



6 ANTI-SLIP SCREWDRIVERS

- Milled 3 · 4 · 5,5 · 6,5
- PH1 · PH2

Ref 351-080
~~48,90 €~~ **28,76 €**



6 ANTI-SLIP SCREWDRIVERS

- Milled 3 · 4 · 5,5 · 6,5
- PZ1 · PZ2

Ref 351-081
~~50,08 €~~ **29,46 €**

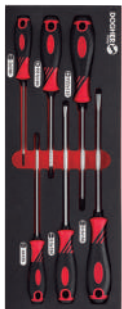

7 INSULATED SCREWDRIVERS 1000V

- Milled 3 · 4 · 5,5 · 6,5
- PH0 · PH1 · PH2

Ref 360-080
~~76,97 €~~ **45,28 €**



7 INSULATED SCREWDRIVERS 1000V

- Milled 3 · 4 · 5,5 · 6,5
- PZ0 · PZ1 · PZ2

Ref 360-081
~~77,55 €~~ **45,62 €**



3 LOCKING PLIERS



125mm · 175mm · 250mm

Ref 276-080
~~84,50 €~~ **49,71 €**



2 HAMMERS

320g Carpenter Hammer
 Ref 702-320

Ø 35 Rubber Hammer
 Ref 742-35

Ref 700-080
~~59,05 €~~ **34,74 €**



26 PIECES

1/2" SOCKET BITS

- 1/2"**
- 4 · 5 · 6 · 7 · 8 · 10
12 · 14 · 17 · 19
T20 · T25 · T27 · T30
T40 · T45 · T50 · T55 · T60
- 5 · 6 · 8 · 10 · 12 · 14 · 16



Ref 534-080
~~398,47 €~~ **222,68 €**

12 PIECES

1/2" DEEP SERIES SOCKET BITS

- 1/2"**
- 100 mm: 5 · 6 · 7 · 8 · 12
140 mm: 5 · 10
- 120 mm: T40 · T55
- 100 mm: 8 · 10 · 12



Ref 538-080
~~246,96 €~~ **138,00 €**

18 Pieces

1/4", 3/8" & 1/2" DEEP SERIES SOCKETS

- 1/4"** 4 · 5 · 6 · 7
8 · 9 · 10
- 3/8"** 10 · 11 · 12 · 13 · 14 · 15
- 1/2"** 16 · 17 · 18 · 19 · 22



Ref 502-080
~~231,48 €~~ **129,35 €**

29 PIECES

1/4" & 1/2" TORX SOCKETS

- 1/2"** E10 · E11 · E12 · E14 · E16
E18 · E20 · E22 · E24
TS20 · TS25 · TS27 · TS30
TS40 · TS45 · TS50 · TS55 · TS60
- 1/4"** E4 · E5 · E6 · E7 · E8
T6 · T7 · T8 · T9 · T10 · T15



Ref 503-080
~~316,58 €~~ **176,93 €**

22 PIECES

3/8" HEXAGONAL

- 3/8"** 6 · 7 · 8 · 9 · 10 · 11 · 12 · 13 · 14
15 · 16 · 17 · 18 · 19 · 20 · 21 · 22

- 72 Teeth Ratchet Handle
- Universal Joint
- Extensions: 75 & 150mm
- Sliding "T" Handle



Ref 516-080
~~250,23 €~~ **139,85 €**

46 PIECES

1/4" HEXAGONAL OR BIHEXAGONAL SOCKETS

- 4 · 4,5 · 5 · 5,5 · 6 · 7 · 8 · 9 · 10 · 11 · 12 · 13 · 14
Long Series: 6 · 7 · 8 · 9 · 10 · 11 · 12 · 13 · 14
- HX3 · HX4 · HX5 · HX6 · HX7 · HX8
- PH1 · PH2 · PH3 PZ1 · PZ2
- T10 · T15 · T20 · T25 · T30 · T40

- 72 Teeth Ratchet Handle
- Universal Joint
- Extensions: 50 & 100mm
- 145mm Flexible Extension
- Spinner Handle
- Sliding "T" Handle



1/4"
Hexagonal Ref 500-081 ~~407,73 €~~ **227,84 €**
Bi-hexagonal Ref 501-081 ~~407,73 €~~ **227,84 €**

13 DRIFT PUNCHES

& PRECISION CENTRE PUNCHES

- Ref 7446 3x10 6x10
 4x10 8x12
 5x10 10x12

- Ref 7449 2,5x7 4x8
 3x7 6x10
 3,5x8 8x12

Ref 750-013



Ref 7446-080
~~133,05 €~~ **78,26 €**



3 ORGANIZERS

Ref 010-080
~~40,53 €~~ **23,84 €**



3 ELECTRICIAN TOOLS

Electrician Scissors with Stripping Notch
Ref. 296-003

Terminal Crimping Tool
Ref 296-056

Automatic Wire Stripper
Ref 296-051



Ref 296-080
~~87,29 €~~ **51,34 €**

4 INSULATED PLIERS 1000V

PLIERS 1000V

- 240 mm 160 mm
- 160 mm 180 mm



Ref 250-081
~~182,86 €~~ **107,57 €**



4 PROFESSIONAL PLIERS

PLIERS

- 160 mm 250 mm
- 180 mm 160 mm

Ref 205-081
~~121,22 €~~ **71,31 €**



10 SCREWDRIVERS

INSULATED 1000V & PROFESSIONAL

- Milled
4 · 5,5 · 6,5
- PH1 · PH2
- Stamped
4 · 5,5 · 6,5
- PH1 · PH2



Ref 330-084

~~98,33 €~~ **57,84 €**

7 PROFESSIONAL

SCREWDRIVERS

- Milled
3 · 4 · 5,5 · 6,5
- PH0 · PH1 · PH2

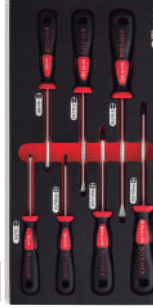

Ref 330-082

~~55,02 €~~ **32,37 €**

7 PROFESSIONAL

SCREWDRIVERS

- Milled
3 · 4 · 5,5 · 6,5
- PZ0 · PZ1 · PZ2

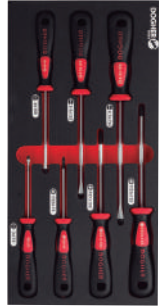

Ref 330-083

~~56,53 €~~ **33,25 €**

10 DOUBLE OPEN ENDED

WRENCHES



6x7 · 8x9 · 10x11 · 12x13
14x15 · 16x17 · 18x19
20x22 · 21x23 · 24x26



Ref 450-081

~~115,49 €~~ **67,93 €**

3 DOUBLE OPEN ENDED

WRENCHES



25x28 · 27x29 · 30x32



Ref 450-082

~~83,26 €~~ **48,97 €**

10 COMBINATION

WRENCHES



8 · 10 · 11 · 12 · 13
14 · 17 · 19 · 22 · 24



Ref 451-081

~~129,91 €~~ **76,41 €**

11 COMBINATION

WRENCHES

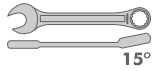

15°

7 · 8 · 10 · 11 · 12 · 13
14 · 17 · 19 · 22 · 24



Ref 451-082

~~136,61 €~~ **80,35 €**

3 COMBINATION

WRENCHES



27 · 30 · 32



Ref 451-083

~~106,67 €~~ **62,75 €**

6 DOUBLE RING

WRENCHES

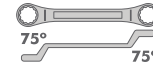

75°

8x9 · 10x11 · 12x13
14x15 · 16x17 · 18x19

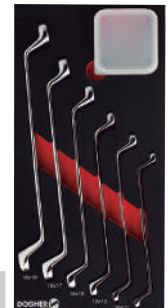

Ref 453-080

~~108,86 €~~ **64,03 €**

9 PIECES

6 DOUBLE BOX 15° GEAR WRENCHES 3 SQUARE DRIVES

1/4" · 3/8" · 1/2"

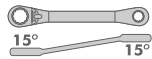

15°

8x9 · 10x11 · 12x13
14x15 · 16x18 · 17x19



Ref 455-080

~~294,32 €~~ **173,13 €**

10 PIECES

7 COMBINATION GEAR WRENCHES 3 SQUARE DRIVES



1/4" · 3/8" · 1/2"

15°

10 · 12 · 13 · 14 · 15 · 17 · 19



Ref 457-080

~~288,92 €~~ **169,96 €**

7 COMBINATION

GEAR WRENCHES



15°

8 · 10 · 13 · 15 · 17 · 19 · 22



Ref 457-081

~~268,33 €~~ **157,85 €**

6 DOUBLE FLEXIBLE SOCKET

WRENCHES



8x9 · 10x11 · 12x13
14x15 · 16x17 · 18x19



Ref 467-080

~~170,31 €~~ **95,18 €**

36 PIECES

1/4" HEXAGONAL SOCKETS

- Folding Key Set: 1,5 · 2 · 2,5 · 3 · 4 · 5 · 6 · 8
- 5,5 · 6 · 7 · 8 · 9 · 10 · 11 · 12 · 13 Deep Series: 6 · 8 · 10 · 12 · 13
- PH1 · PH2 · PH3 PZ1 · PZ2 · PZ3
- HX3 · HX4 · HX5 HX6 · HX7 4 · 5,5 · 6,5

- 72 Teeth Ratchet Handle
- Universal Joint
- Extensions: 50 & 100mm
- Sliding "T" Handle
- Spinner Handle
- Palm Driver



Ref 500-083
~~340,43 €~~ **190,24 €**

27 PIECES

1/2" HEXAGONAL OR BIHEXAGONAL SOCKETS

- 8 · 9 · 10 · 11 · 12 · 13 · 14 · 15 · 16 · 17
18 · 19 · 20 · 21 · 22 · 23 · 24 · 27 · 30 · 32
- Spark Plug: 16 · 21

- 72 Teeth Ratchet Handle
- Universal Joint 3/8" 1/2"
- Extensions: 125 & 250mm
- Universal Joint

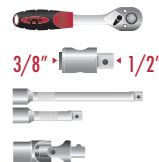

Hexagonal Ref 531-080 ~~341,00 €~~ **190,54 €**
 Bi-hexagonal Ref 530-080 ~~341,00 €~~ **190,54 €**

25 PIECES

1/2" IMPACT SOCKETS

- 8 · 9 · 10 · 11 · 12 · 13 · 14 · 15 · 16
17 · 18 · 20 · 21 · 22 · 24
- Deep Series: 17 · 19 · 21 · 22 · 24
- Colour Impact Sockets: 17 · 19 · 21

- Impact Universal Joint
- Extension: 125 mm

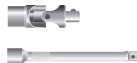

Ref 570-080
~~416,59 €~~ **245,06 €**

23 PIECES

1/2" IMPACT SOCKETS

- E10 · E12 · E14 · E16 · E18 · E20 · E24
- T25 · T27 · T30 · T40 · T45 · T50 · T55 · T60
- 5 · 6 · 8 · 10 · 12 · 14 · 17 · 19

Ref 572-080
~~541,34 €~~ **302,53 €**



7 PIECES

3 WAY T-TYPE SLIDING HEX KEY WRENCH

- 2 · 2,5 · 3 · 4 · 5 · 6 · 8

Ref 623-080
~~180,88 €~~ **106,40 €**



9 PIECES

PERCUSSION

- Rivoir French Style Hammers Fiberglass Handle 35 mm
- Long Drift Punch 3x10mm
- Long Drift Punch 4x10mm
- Long Drift Punch 5x10mm
- Long Drift Punch 6x10mm
- Long Drift Punch 8x12mm
- Long Drift Punch 10x12mm
- Rubber Hammer Fiberglass Handle 35 mm
- Cold Chisel 13x23x30x250 mm

Ref 729-080
~~134,75 €~~ **79,25 €**



8 CIRCLIP®

PLIERS PRO

- 140 / 180 mm
- 140 / 180 mm
- 140 / 180 mm
- 140 / 180 mm

Ref 220X-081
~~247,59 €~~ **145,65 €**



11 6X6 ANGLED

OPEN SOCKET WRENCHES

- 8 · 10 · 11 · 12 · 13 · 14
· 15 · 16 · 17 · 18 · 19

Ref 462-080
~~234,61 €~~ **138,00 €**



43 PIECES**1/4" & 1/2" HEXAGONAL OR BIHEXAGONAL SOCKETS**

1/2" 10 · 11 · 12 · 13 · 14 · 15 · 16 · 17 · 18 · 19 · 20 · 21
22 · 24 · 27 · 30 · 32 Spark Plug: 16 · 21

1/4" 4 · 4,5 · 5 · 5,5 · 6 · 7 · 8
9 · 10 · 11 · 12 · 13 · 14

72 Teeth Ratchet Handle



72 Teeth Ratchet Handle



3-Way Adapter



Extensions: 50 & 100mm



Extensions: 125 & 250mm



Universal Joint



Universal Joint



Spinner Handle



Sliding "T" Handle



Hexagonal Ref 500-080 ~~487,51 €~~ **258,10 €**

Bi-hexagonal Ref 501-080 ~~487,51 €~~ **258,10 €**

**10** BALL NOSE HEX**T-HANDLE**

2 · 2,5 · 3 · 4 · 5 · 6 · 7 · 8 · 10 · 12

Ref 618-080

~~171,10 €~~ **100,63 €**

**10** HEX**T-HANDLE**

2 · 2,5 · 3 · 4 · 5 · 6 · 7 · 8 · 10 · 12

Ref 617-080
~~170,05 €~~ **100,03 €**

10 TORX TAMPER**T-HANDLE**

TS9 · TS10 · TS15 · TS20 · TS25 · TS27 · TS30 · TS40 · TS45 · TS50

Ref 620-080
~~145,67 €~~ **85,69 €**

4 LOCKING**PLIERS**

Part N° 275F-010 · 275F-011
275F-012 · 275F-013

Ref 275F-080
~~357,40 €~~ **210,24 €**

**3** PERCUSSION

Part N° 7310-50 · 700-680 · 7331-35



Ref 700-085
~~147,92 €~~ **87,01 €**

5 ELECTRICIAN**TRAY**

Part N° 795-002 · 296-132 · 296-152
296-060 · 204-200



Ref 795-080
~~215,19 €~~ **126,59 €**

6 AUTOMOTIVE**PLIERS**

Part N° 2200-005 · 2200-010 · 2200-011
2200-012 · 2200-30 · 2200-25



Ref 2200-080
~~360,15 €~~ **211,85 €**

31 PIECES**MIXED**

UPE Hammer knock in Head Hickory Handle Dead Blow 35 mm

Ball Pen Hammers Hickory Handle 455 grs.

Magnetic Measuring Tape 3 m

Screw Locking Knife Cutter 18 mm

Bi-material Handle Flat File 2nd Cut 200 mm

Bi-material Handle Flat File Bastard Cut 200 mm

Professional Electrician Scissors 145 mm

Key Wrench Set Extra Long Ball Nose Hex 9 pieces 1,5-10

10 Bi-Metal Hacksaw Blades 300x13x0,65

Hand Hacksaw Frame 300 mm

Long Drift Punch 4x10 mm

Long Drift Punch 5x10 mm

Long Drift Punch 6x10 mm

Button Quick Release Water Pump Plier 240 mm

Ref 840-080
~~296,82 €~~ **174,59 €**



155 PCS

MULTITOOLS



1/4" Screwdriver Bits 1/4" · 25 mm

PH0 · PH1 · PH2 · PH3 · PH4

PZ0 · PZ1 · PZ2 · PZ3 · PZ4

3 · 3,5 · 4 · 4,5 · 5 · 5,5 · 6 · 6,5 · 8

T5 · T6 · T7 · T8 · T9 · T10 · T15 · T20 · T25 · T27 · T30 · T40

HX1,5 · HX2 · HX2,5 · HX3
HX4 · HX5 · HX6 · HX8 · HX10

R1 · R2 · R3

TS10 · TS15 · TS20
TS25 · TS27 · TS30 · TS40

1/4" Screwdriver Bits 1/4" · 50 mm

PH1 · PH2 · PH3 · PH4

PZ1 · PZ2 · PZ3 · PZ4

3 · 3,5 · 4 · 4,5 · 5 · 5,5 · 6 · 6,5 · 8

HX2 · HX2,5 · HX3
HX4 · HX5 · HX6 · HX8

R1 · R2 · R3

T5 · T6 · T7 · T8 · T9 · T10 · T15 · T20 · T25 · T27 · T30 · T40

5/16" Screwdriver Bits 5/16" · 30 mm

T40 · T45 · T50 · T55

Ref 500-084
~~448,45 €~~ 263,79 €

1/4" Ratched Handle 72 teeth (510-001)

Extensions 150 mm (509-007)
50 mm (509-006)

Universal Joint (509-009)

4-4,5-5-5,5-6-7-8-9-10-11-12-13-14

1/2" Ratched Handle 72 teeth (544-001)

Extensions 125 mm (543-003)
75 mm (543-002)

Universal Joint (543-009)

9 Pcs (605-009) Key Wrench Set Extra Long Ball Nose Hex

Spinner Handle (509-017)
Hexagonal Shank Socket Adaptor 1/4" · 1/4" (509-019)

Square Drive Bit Holders 1/4" · 1/4" (509-012)

4, 5, 5,7-8-10-11-13

Square Drive Bit Holders 1/2" · 5/16" (543-018)

Square Drive Bit Holders 1/2" · 1/4" (543-028)

8- 9-10-11-12-13-14-15
16-17-19-22-24-25-27-30

10- 11-13-17-19

NEW RANGE CONSTRUCTION

- ▶ Clamps.
- ▶ Telescopic Prop.

Marquetry clamps



Piston system clamps



Automatic clamps



Telescopic Prop



More information available on pages 454-456 of the New Catalogue 2023-2024.

RECOMMENDED RETAIL PRICES - EXCLUDING VAT



DOGHER TOOLS, S.A.
Polígono Industrial Arriandi
Tabernabarri Nº5 · 48215 Iurreta Vizcaya (Spain)
Tel.: +34 946216145 · Fax: +34 946216147
comercial@dogher.com · export@dogher.com
www.dogher.com

Promotion valid from 01/09/2023



20²³
24
PROMOTION

PROMO2023EN

