

# DOGHER

TOOLS

Making Solutions



188



232



192

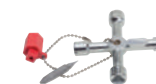

233



196



235



203

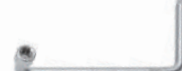

236



208



237



212



238



213



239



218



240



220



243



223



226



228

# Clés 450

# Clés à Molette

Molette Latérale et Ouverture Extra



491

Clé à Molette Latérale

CrV

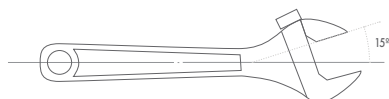

L mm	L "	mm	Part N°	€
150	6	24	491-150	33,33
200	8	29	491-200	37,36
250	10	33	491-250	45,91
300	12	38	491-300	59,83
400	16	50	491-400	99,98
500	20	62	491-500	165,32



230 x 210 x 155 mm

EXP

10 Clés à Molette Latérale

10  
Pcs

CrV



491-200 (x4)  
491-250 (x6)

Part N°	€
491-001J	424,90

492

Clé à Molette Ouverture Extra

CrV

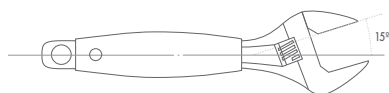

L mm	L "	mm	Part N°	€
150	6	34	492-150	31,22
200	8	38	492-200	33,85
250	10	50	492-250	42,28

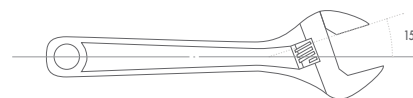

**493**

Clé à Molette Professionnelle

CrV



230 x 210 x 155 mm

L mm	L "	mm	Part N°	€
100	4	17	493-100	20,18
150	6	24	493-150	20,54
200	8	29	493-200	22,14
250	10	33	493-250	27,54
300	12	38	493-300	37,12
380	15	50	493-380	68,63
450	18	60	493-450	105,86
600	24	70	493-600	255,92

**EXP**

10 Clés à Molette Professionnelles

**10**  
Pcs

CrV

Part N°	€
493-001J	253,80

493-200 (x4)  
493-250 (x6)



**4930**

Clé à Molette

CrV



230 x 210 x 155 mm

L mm	L "	mm	Part N°	€
100	4	13	4930-100	16,49
150	6	19	4930-150	17,12
200	8	24	4930-200	17,77
250	10	28	4930-250	22,75
300	12	34	4930-300	30,65
380	15	43	4930-380	56,68
450	18	52	4930-450	96,59
600	24	62	4930-600	154,55

**EXP**

10 Clés à Molette

**10**  
Pcs

CrV

Part N°	€
4930-001J	207,58

4930-200 (x4)  
4930-250 (x6)



# Clés à Molette

À Cliquet et Alligator



496

Clé à Molette à Cliquet

CrV

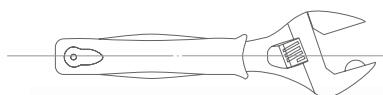

L mm	L "	mm	Part N°	€
150	6	6~20	496-150	29,20
200	8	6~24	496-200	33,52
250	10	6~30	496-250	49,79

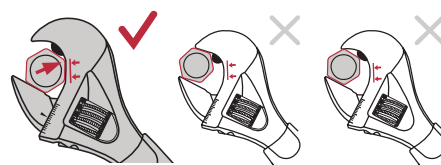

• Placer la clé comme indiqué dans l'image ci-dessus.



160 x 190 x 125 mm

EXP

10 Clés à Molette à Cliquet

10  
Pcs

CrV



496-200 (x10)

Part N°	€
496-001J	335,20

4931

Clé à Molette

## Alligator

CrV



L mm	L "	mm	mm	Part N°	€
200	8	32	M3-M10	4931-200	36,78

EXP

10 Clés à Molette

10  
Pcs

CrV



230 x 210 x 155 mm



4931-200 (x10)

Part N°	€
4931-200J	367,80

**491**

Panneau de Mousse Modulaire

**3**

Pcs

CrV



1/4 (375 x 140 x 30 mm)



150mm • 200mm • 250mm

Part N°	€
<b>491-080</b>	<b>125,85</b>

**493**

Panneau de Mousse Modulaire

**3**

Pcs

CrV



1/4 (375 x 140 x 30 mm)



150mm • 200mm • 250mm

Part N°	€
<b>493-080</b>	<b>79,47</b>

Voir pour Plus d'information sur le Rangement et Panneaux de Mousse Modulables Pages:

20 • 35

# Clés Fixes

Les clés DOGHER sont forgées en chrome vanadium, trempées par chauffage continu et refroidies en bain d'huile. Ce processus donne à l'outil une grande dureté et ténacité. Le corps entier est poli, maximisant la résistance à l'oxydation.

## Clés à Fourches



450

Clé à Fourches

CrV



## SAE

A mm	B mm	L mm	Part N°	€
4	5	110	450-04-05	5,01
4,5	5,5	123	450-04,5-05,5	5,01
5	5,5	123	450-05-05,5	5,01
5,5	7	123	450-05,5-07	5,01
6	7	123	450-06-07	5,01
7	8	129	450-07-08	5,25
8	9	140	450-08-09	5,25
8	10	141	450-08-10	5,73
10	11	155	450-10-11	5,73
10	12	156	450-10-12	6,86
10	13	170	450-10-13	7,00
11	13	172	450-11-13	7,00
12	13	172	450-12-13	7,00
12	14	179	450-12-14	7,15
13	15	189	450-13-15	7,46
13	17	205	450-13-17	8,54
14	15	190	450-14-15	7,70
16	17	204	450-16-17	8,61
16	18	210	450-16-18	9,32
17	19	221	450-17-19	9,99
18	19	220	450-18-19	10,04
19	22	237	450-19-22	11,85
20	22	237	450-20-22	12,22
21	23	247	450-21-23	13,20
22	24	247	450-22-24	13,42
24	26	263	450-24-26	14,93
24	27	266	450-24-27	15,71
25	28	280	450-25-28	17,17
27	29	280	450-27-29	20,24
27	30	285	450-27-30	21,76
27	32	300	450-27-32	22,05
30	32	298	450-30-32	23,02
32	36	350	450-32-36	40,54
34	36	350	450-34-36	43,97
36	41	380	450-36-41	47,75
41	46	415	450-41-46	68,09
46	50	465	450-46-50	87,59

A "	B "	L mm	Part N°	€
1/4"	5/16"	123	450-1/4-5/16	5,39
5/16"	3/8"	140	450-5/16-3/8	5,60
3/8"	7/16"	156	450-3/8-7/16	6,54
7/16"	1/2"	172	450-7/16-1/2	7,40
1/2"	9/16"	172	450-1/2-9/16	8,53
9/16"	5/8"	188	450-9/16-5/8	9,53
5/8"	11/16"	204	450-5/8-11/16	10,51
11/16"	3/4"	220	450-11/16-3/4	12,51
13/16"	7/8"	238	450-13/16-7/8	14,97
15/16"	1"	266	450-15/16-1	20,10
1"	1.1/8"	280	450-1-1.1/8	23,08
1.1/16"	1.1/4"	298	450-1.1/16-1.1/4	28,27



• Nous consulter pour présentation brochable

450

Trousse Tissu

8  
Pcs

CrV



390 x 300 mm



- 6x7 • 8x9 • 10x11 • 12x13 • 14x15 • 16x17
- 18x19 • 20x22

Part N°	€
450-001	67,81
450-001V *	21,11

\* Trousse Tissu Vide

450

Trousse Tissu

12  
Pcs

CrV



620 x 350 mm



- 6x7 • 8x9 • 10x11 • 12x13 • 14x15 • 16x17
- 18x19 • 20x22 • 21x23 • 24x27 • 25x28 • 30x32

Part N°	€
450-002	137,91
450-002V *	24,15

\* Trousse Tissu Vide

450

Trousse Tissu

7  
Pcs

CrV

SAE



300 x 390 mm



- 1/4" x 5/16" • 5/16" x 3/8" • 3/8" x 7/16"
- 1/2" x 9/16" • 9/16" x 5/8" • 5/8" x 11/16"
- 11/16" x 3/4"

Part N°	€
450-003	64,86
450-003V *	21,11

\* Trousse Tissu Vide

450

Trousse Tissu

11  
Pcs

CrV

SAE



620 x 350 mm



- 1/4" x 5/16" • 5/16" x 3/8" • 3/8" x 7/16"
- 1/2" x 9/16" • 9/16" x 5/8" • 5/8" x 11/16"
- 11/16" x 3/4" • 13/16" x 7/8" • 15/16" x 1"
- 1" x 1.1/8" • 1.1/16" x 1.1/4"

Part N°	€
450-004	152,28
450-004V *	24,15

\* Trousse Tissu Vide

# Clés Fixes

Jeux de Clés à Fourches



450

Présentoir Plastique

6  
Pcs

CrV



• 6x7 • 8x9 • 10x11 • 12x13 • 14x15 • 16x17

Part N°	€
450-016	47,55
450-011V *	15,44

\* Présentoir Plastique Vide

8  
Pcs

CrV



• 6x7 • 8x9 • 10x11 • 12x13 • 14x15 • 16x17  
• 18x19 • 20x22

Part N°	€
450-018	69,81
450-013V *	18,01

\* Présentoir Plastique Vide

450

Présentoir Plastique

10  
Pcs

CrV



• 6x7 • 8x9 • 10x11 • 12x13 • 14x15 • 16x17  
• 18x19 • 20x22 • 21x23 • 24x27

Part N°	€
450-020	98,72
450-015V *	23,15

\* Présentoir Plastique Vide

12  
Pcs

CrV



• 6x7 • 8x9 • 10x11 • 12x13 • 14x15 • 16x17  
• 18x19 • 20x22 • 21x23 • 24x27 • 25x28 • 27x29

Part N°	€
450-022	136,13
450-017V *	24,45

\* Présentoir Plastique Vide

12  
Pcs

CrV



• 6x7 • 8x9 • 10x11 • 12x13 • 14x15 • 16x17  
• 18x19 • 20x22 • 21x23 • 24x26 • 25x28 • 30x32

Part N°	€
450-024	138,13
450-017V *	24,45

\* Présentoir Plastique Vide



450

Étui Carton

5  
Pcs

CrV



• 6x7 • 8x9 • 10x11 • 12x13 • 14x15

Part N°	€
450-035	38,94

450

Étui Carton

6  
Pcs

CrV



• 6x7 • 8x9 • 10x11 • 12x13 • 14x15 • 16x17

Part N°	€
450-036	47,55

450

Étui Carton

8  
Pcs

CrV



• 6x7 • 8x9 • 10x11 • 12x13  
• 14x15 • 16x17 • 18x19 • 20x22

Part N°	€
450-038	69,81

450

Panneau de Mousse Modulaire

8  
Pcs

CrV



1/4 (375 x 140 x 30 mm)



• 6x7 • 8x9 • 10x11 • 12x13 • 14x15  
• 16x17 • 18x19 • 20x22

Part N°	€
450-080	70,81

450

Panneau de Mousse Modulaire

10  
Pcs

CrV



1/3 (375 x 188 x 30 mm)



• 6x7 • 8x9 • 10x11 • 12x13 • 14x15  
• 16x17 • 18x19 • 20x22 • 21x23 • 24x26

Part N°	€
450-081	102,19

450

Panneau de Mousse Modulaire

3  
Pcs

CrV



1/3 (375 x 188 x 30 mm)



• 25x28 • 27x29 • 30x32

Part N°	€
450-082	72,93

# Clés Fixes

## Clés Mixtes

- Répartition optimale des efforts
- Serrage rapide
- Rendement maximum sans usure
- Réduction de l'usure sur les boulons et vis
- Vie utile de la clé plus importante
- Surface de contact maximale
- Distribution homogène de l'effort

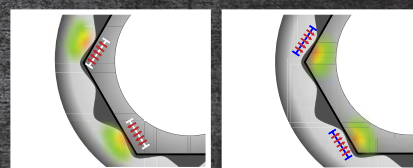

• Sur la clé

• Sur le boulon

451

Clé Mixte

CrV

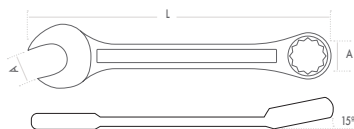

SAE

A"	L mm	Part N°	€
7/32"	100	451-7/32	6,33
1/4"	100	451-1/4	6,66
9/32"	110	451-9/32	5,93
5/16"	120	451-5/16	6,86
11/32"	130	451-11/32	5,93
3/8"	140	451-3/8	7,96
7/16"	150	451-7/16	8,55
1/2"	170	451-1/2	8,90
9/16"	180	451-9/16	9,08
5/8"	200	451-5/8	11,18
11/16"	210	451-11/16	12,16
3/4"	230	451-3/4	14,27
13/16"	250	451-13/16	16,49
7/8"	260	451-7/8	17,16
15/16"	280	451-15/16	18,41
1"	290	451-1	20,09
1.1/16"	310	451-1.1/16	21,37
1.1/8"	330	451-1.1/8	27,27
1.1/4"	360	451-1.1/4	32,50
1.5/16"	380	451-1.5/16	40,72
1.3/8"	410	451-1.3/8	55,30
1.7/16"	410	451-1.7/16	56,22
1.1/2"	410	451-1.1/2	60,27
1.5/8"	460	451-1.5/8	72,83
1.11/16"	460	451-1.11/16	94,08
1.3/4"	500	451-1.3/4	100,92
1.13/16"	500	451-1.13/16	93,88
1.7/8"	540	451-1.7/8	107,36
2"	540	451-2	108,81
2.1/8"	560	451-2.1/8	191,42
2.1/4"	600	451-2.1/4	191,42
2.3/8"	600	451-2.3/8	264,57
2.1/2"	680	451-2.1/2	327,89
2.5/8"	680	451-2.5/8	327,89
2.3/4"	680	451-2.3/4	348,76
2.7/8"	730	451-2.7/8	423,27
3"	730	451-3	423,27

A mm	L mm	Part N°	€
4	80	451-04	6,72
5,5	100	451-05,5	6,81
6	100	451-06	5,12
7	110	451-07	5,15
8	120	451-08	5,24
9	130	451-09	5,61
10	140	451-10	5,62
11	150	451-11	5,81
12	160	451-12	6,12
13	170	451-13	6,54
14	180	451-14	6,69
15	190	451-15	7,41
16	200	451-16	7,97
17	210	451-17	9,21
18	220	451-18	9,38
19	230	451-19	10,16
20	240	451-20	11,36
21	250	451-21	11,70
22	260	451-22	11,99
23	270	451-23	12,66
24	280	451-24	13,30
25	290	451-25	14,33
26	300	451-26	15,93
27	310	451-27	17,45
28	320	451-28	18,60
29	330	451-29	18,87
30	340	451-30	20,36
32	360	451-32	22,13
33	380	451-33	53,51
34	380	451-34	55,05
35	410	451-35	69,14
36	410	451-36	57,84
38	430	451-38	72,46
41	460	451-41	75,06
43	460	451-43	116,18
46	500	451-46	99,45
48	540	451-48	105,57
50	540	451-50	119,35
55	560	451-55	179,54
58	600	451-58	284,72
60	600	451-60	249,13
65	680	451-65	332,08
70	680	451-70	390,78
75	730	451-75	502,93
80	730	451-80	576,30
85	790	451-85	779,88
90	790	451-90	1.009,35
95	790	451-95	1.067,49
100	860	451-100	1.138,21
105	860	451-105	1.175,10

451

Trousse Tissu

14  
Pcs

CrV



470 x 390 mm



Part N°	€
451-001	122,82
451-001V *	20,91

\* Trousse Tissu Vide

451

Trousse Tissu

14  
Pcs

CrV



650 x 440 mm



Part N°	€
451-002	154,73
451-002V *	24,40

\* Trousse Tissu Vide

451

Trousse Tissu

17  
Pcs

CrV



470 x 450 mm



Part N°	€
451-003	141,33
451-003V *	20,91

\* Trousse Tissu Vide

451

Trousse Tissu

18  
Pcs

CrV



650 x 480 mm



Part N°	€
451-004	200,62
451-004V *	23,48

\* Trousse Tissu Vide

# Clés Fixes

Jeux de Clés Mixtes



451

Trousse Tissu

24  
Pcs

CrV

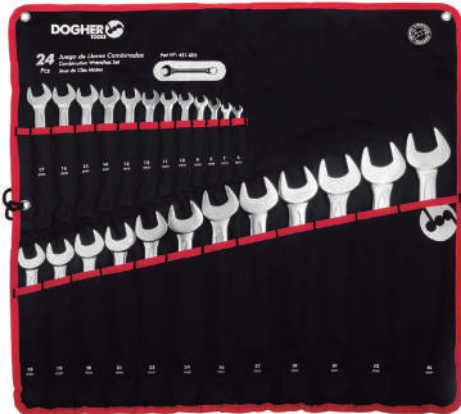

650 x 580 mm

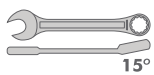

• 6 • 7 • 8 • 9 • 10 • 11 • 12 • 13 • 14  
• 15 • 16 • 17 • 18 • 19 • 20 • 21 • 22 • 24  
• 26 • 27 • 28 • 30 • 32 • 36

Part N°	€
451-005	306,94
451-005V *	28,42

\* Trousse Tissu Vide

451

Trousse Tissu

26  
Pcs

CrV



650 x 500 mm

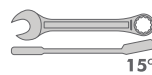

• 6 • 7 • 8 • 9 • 10 • 11 • 12 • 13 • 14  
• 15 • 16 • 17 • 18 • 19 • 20 • 21 • 22 • 23  
• 24 • 25 • 26 • 27 • 28 • 29 • 30 • 32

Part N°	€
451-006	294,96
451-006V *	28,42

\* Trousse Tissu Vide

451

Trousse Tissu

8  
Pcs

SAE

CrV



330 x 300 mm

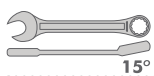

• 1/4" • 5/16" • 3/8" • 7/16" • 1/2" • 9/16"  
• 5/8" • 11/16"

Part N°	€
451-007	77,60
451-007V *	19,07

\* Trousse Tissu Vide

451

Trousse Tissu

12  
Pcs

SAE

CrV



550 x 350 mm

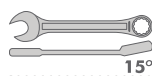

• 3/8" • 7/16" • 1/2" • 9/16" • 5/8" • 11/16"  
• 3/4" • 13/16" • 7/8" • 15/16" • 1" • 1.1/16"

Part N°	€
451-008	172,87
451-008V *	23,86

\* Trousse Tissu Vide

451

Trousse Tissu

**14**  
Pcs

SAE

CrV



650 x 440 mm

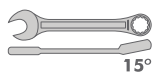

• 3/8" • 7/16" • 1/2" • 9/16" • 5/8"  
• 11/16" • 3/4" • 13/16" • 7/8" • 15/16"  
• 1" • 1.1/16" • 1.1/8" • 1.1/4"

Part N°	€
451-009	233,64
451-009V *	24,40

\* Trousse Tissu Vide

451

Étui Carton

**5**  
Pcs

CrV

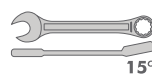

• 8 • 10 • 11 • 12 • 13

Part N°	€
451-035	37,58

451

Étui Carton

**6**  
Pcs

CrV

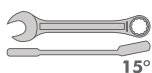

• 8 • 10 • 11 • 12 • 13 • 14

Part N°	€
451-036	44,27

451

Étui Carton

**8**  
Pcs

CrV

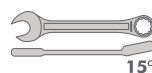

• 8 • 10 • 11 • 12 • 13 • 14 • 17 • 19

Part N°	€
451-038	63,64

# Clés Fixes

Jeux de Clés Mixtes



451

Présentoir Plastique

5  
Pcs

CrV

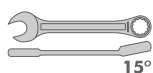

8 • 10 • 13 • 17 • 19

6  
Pcs

CrV

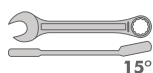

8 • 10 • 11 • 13 • 17 • 19

6  
Pcs

CrV

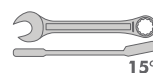

8 • 10 • 11 • 12 • 13 • 14

Part N°	€
451-014	45,02
450-011V *	15,44

\* Présentoir Plastique Vide

Part N°	€
451-015	50,83
450-011V *	15,44

\* Présentoir Plastique Vide

Part N°	€
451-016	44,27
450-011V *	15,44

\* Présentoir Plastique Vide

451

Présentoir Plastique

8  
Pcs

CrV

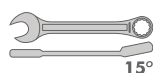

8 • 10 • 11 • 12 • 13 • 14 • 17 • 19

10  
Pcs

CrV

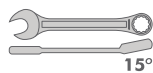

8 • 9 • 10 • 11 • 12  
13 • 14 • 15 • 16 • 17

12  
Pcs

CrV

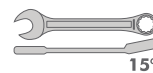

8 • 9 • 10 • 11 • 12 • 13  
14 • 15 • 16 • 17 • 18 • 19

Part N°	€
451-018	63,64
450-013V *	18,01

\* Présentoir Plastique Vide

Part N°	€
451-020	74,47
450-015V *	23,15

\* Présentoir Plastique Vide

Part N°	€
451-022	94,01
450-017V *	24,45

\* Présentoir Plastique Vide

**451**

Panneau de Mousse Modulable

**8**  
Pcs

CrV



1/4 (375 x 140 x 30 mm)

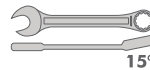

• 8 • 10 • 11 • 12 • 13 • 14 • 17 • 19

Part N°	€
<b>451-080</b>	<b>64,64</b>

**451**

Panneau de Mousse Modulable

**11**  
Pcs

CrV



1/3 (375 x 188 x 30 mm)

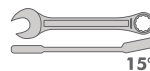

• 7 • 8 • 10 • 11 • 12 • 13 • 14  
• 17 • 19 • 22 • 24

Part N°	€
<b>451-082</b>	<b>98,33</b>

**451**

Clés Mixtes

**10**  
Pcs



1/3 (375 x 188 x 30 mm)

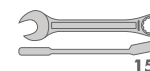

• 8 • 10 • 11 • 12 • 13 • 14 • 17 • 19 • 22 • 24

Part N°	€
<b>451-081</b>	<b>93,18*</b>

\* Jusqu'à fin des stocks

**451**

Panneau de Mousse Modulable

**3**  
Pcs

CrV



1/3 (375 x 188 x 30 mm)

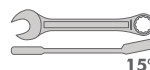

• 27 • 30 • 32

Part N°	€
<b>451-083</b>	<b>72,44</b>

# Clés Fixes

Clés Mixtes



**4551**

Clé Mixte Série Longue

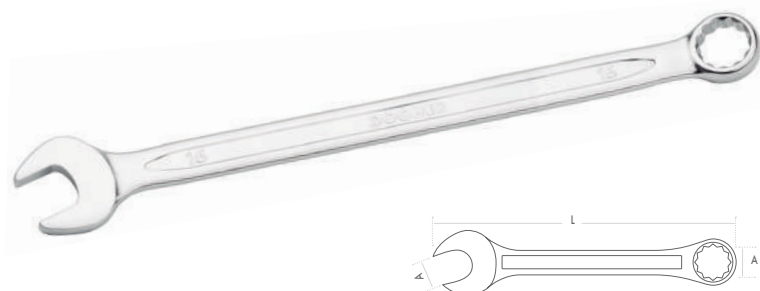

A mm	L mm	Part N°	€
<b>7</b>	136	<b>4551-07</b>	<b>7,82</b>
<b>8</b>	148	<b>4551-08</b>	<b>7,98</b>
<b>9</b>	167	<b>4551-09</b>	<b>7,98</b>
<b>10</b>	172	<b>4551-10</b>	<b>8,81</b>
<b>11</b>	186	<b>4551-11</b>	<b>8,81</b>
<b>12</b>	197	<b>4551-12</b>	<b>10,07</b>
<b>13</b>	207	<b>4551-13</b>	<b>10,07</b>
<b>15</b>	233	<b>4551-15</b>	<b>12,15</b>
<b>17</b>	261	<b>4551-17</b>	<b>13,77</b>
<b>19</b>	280	<b>4551-19</b>	<b>17,44</b>
<b>21</b>	301	<b>4551-21</b>	<b>17,44</b>
<b>24</b>	338	<b>4551-24</b>	<b>22,32</b>
<b>27</b>	375	<b>4551-27</b>	<b>28,94</b>
<b>32</b>	435	<b>4551-32</b>	<b>35,03</b>

**4561**

Clé Mixte Type Twist



A mm	L mm	Part N°	€
<b>6</b>	110	<b>4561-06</b>	<b>7,14</b>
<b>7</b>	120	<b>4561-07</b>	<b>7,14</b>
<b>8</b>	130	<b>4561-08</b>	<b>7,31</b>
<b>9</b>	140	<b>4561-09</b>	<b>7,31</b>
<b>10</b>	150	<b>4561-10</b>	<b>8,05</b>
<b>11</b>	160	<b>4561-11</b>	<b>8,05</b>
<b>12</b>	170	<b>4561-12</b>	<b>9,22</b>
<b>13</b>	180	<b>4561-13</b>	<b>9,22</b>
<b>14</b>	190	<b>4561-14</b>	<b>11,14</b>
<b>15</b>	200	<b>4561-15</b>	<b>11,14</b>
<b>16</b>	210	<b>4561-16</b>	<b>12,22</b>
<b>17</b>	220	<b>4561-17</b>	<b>12,59</b>
<b>18</b>	230	<b>4561-18</b>	<b>12,68</b>
<b>19</b>	240	<b>4561-19</b>	<b>15,95</b>



**4510**

Clés Mixtes Contre-Coudées



A mm	L mm	Part N°	€
6	110	4510-06	6,58
7	120	4510-07	6,49
8	130	4510-08	6,62
9	140	4510-09	7,33
10	150	4510-10	7,40
11	160	4510-11	7,72
12	170	4510-12	8,21
13	180	4510-13	8,78
14	190	4510-14	8,97
15	200	4510-15	9,94
16	210	4510-16	10,69
17	220	4510-17	12,35
18	230	4510-18	12,58
19	240	4510-19	13,64
20	250	4510-20	15,25
21	260	4510-21	15,69
22	270	4510-22	16,08
23	280	4510-23	16,98
24	290	4510-24	17,85
25	300	4510-25	19,23
26	310	4510-26	22,96
27	320	4510-27	25,16
28	330	4510-28	26,82
29	340	4510-29	27,21
30	350	4510-30	29,09
32	370	4510-32	31,91

**4510**

Présentoir Plastique

**5**  
Pcs



8 • 10 • 13 • 17 • 19

Part N°	€
4510-014	57,04
450-011V *	15,44

\* Présentoir Plastique Vide

**4510**

Présentoir Plastique

**6**  
Pcs



8 • 10 • 12 • 13 • 14 • 17

Part N°	€
4510-016	60,58
450-011V *	15,44

\* Présentoir Plastique Vide

**4510**

Présentoir Plastique

**12**  
Pcs

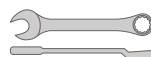

8 • 9 • 10 • 11 • 12 • 13 • 14 • 15 • 16 • 17 • 18 • 19

Part N°	€
4510-022	122,48
450-017V *	24,45

\* Présentoir Plastique Vide

# Clés Fixes

Clés Polygonales Plates



454

Clé Polygonale Plate

CrV

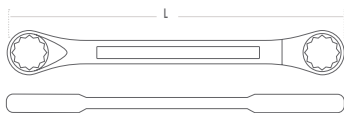

mm	mm	L mm	Part N°	€
6	7	120	454-06-07	8,83
8	9	135	454-08-09	9,15
10	11	150	454-10-11	10,14
12	13	165	454-12-13	11,10
13	17	210	454-13-17	11,78
14	15	185	454-14-15	12,17
16	17	210	454-16-17	13,05
17	19	225	454-17-19	13,57
18	19	225	454-18-19	13,57
20	22	240	454-20-22	15,71
21	23	255	454-21-23	18,03
24	26	270	454-24-26	22,16
24	27	270	454-24-27	22,16
25	28	285	454-25-28	22,75
27	29	315	454-27-29	27,46
30	32	335	454-30-32	28,85

454

Panneau de Mousse Modulable

8  
Pcs

CrV



1/4 (375 x 140 x 30 mm)



Part N°	€
454-080	102,97

Voir pour Plus d'information sur le Rangement et Panneaux de Mousse Modulables Pages:

20 • 35

**454**

Présentoir Plastique

**6**  
Pcs

CrV



 • 6x7 • 8x9 • 10x11 • 12x13 • 14x15 • 16x17

Part N°	€
454-016	72,69
450-011V *	15,44

\* Présentoir Plastique Vide

**454**

Présentoir Plastique

**8**  
Pcs

CrV



 • 6x7 • 8x9 • 10x11 • 12x13 • 14x15 • 16x17 • 18x19 • 20x22

Part N°	€
454-018	101,97
450-013V *	18,01

\* Présentoir Plastique Vide

**454**

Présentoir Plastique

**10**  
Pcs

CrV



 • 6x7 • 8x9 • 10x11 • 12x13 • 14x15 • 16x17 • 18x19  
 • 20x22 • 21x23 • 24x27

Part N°	€
454-020	142,16
450-015V *	23,15

\* Présentoir Plastique Vide



**454**

Présentoir Plastique

**12**  
Pcs

CrV



 • 6x7 • 8x9 • 10x11 • 12x13 • 14x15 • 16x17 • 18x19  
 • 20x22 • 21x23 • 24x27 • 25x28 • 27x29

Part N°	€
454-022	192,37
450-017V *	24,45

\* Présentoir Plastique Vide

# Clés Fixes

Jeux de Clés Polygonales Plates



454

Trousse Tissu

8  
Pcs

CrV



390 x 380 mm



- 6x7
- 8x9
- 10x11
- 12x13
- 14x15
- 16x17
- 18x19
- 20x22

Part N°	€
454-001	99,97
454-001V *	20,16

\* Trousse Tissu Vide

454

Trousse Tissu

10  
Pcs

CrV



620 x 480 mm



- 6x7
- 8x9
- 10x11
- 12x13
- 14x15
- 16x17
- 18x19
- 20x22
- 21x23
- 24x26

Part N°	€
454-002	140,16
454-002V *	22,45

\* Trousse Tissu Vide

454

Trousse Tissu

12  
Pcs

CrV



620 x 480 mm



- 6x7
- 8x9
- 10x11
- 12x13
- 14x15
- 16x17
- 18x19
- 20x22
- 21x23
- 24x26
- 25x28
- 30x32

Part N°	€
454-003	193,76
454-003V *	23,37

\* Trousse Tissu Vide

**4554**

Clé Polygonale Plate Série Longue

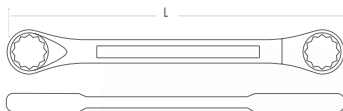

A mm	L mm	Part N°	€
<b>8 x 10</b>	235	<b>4554-08-10</b>	<b>30,90</b>
<b>10 x 12</b>	290	<b>4554-10-12</b>	<b>34,22</b>
<b>12 x 14</b>	328	<b>4554-12-14</b>	<b>37,57</b>
<b>13 x 15</b>	328	<b>4554-13-15</b>	<b>43,35</b>
<b>13 x 17</b>	390	<b>4554-13-17</b>	<b>43,35</b>
<b>16 x 18</b>	404	<b>4554-16-18</b>	<b>46,14</b>
<b>17 x 19</b>	404	<b>4554-17-19</b>	<b>47,83</b>
<b>22 x 24</b>	435	<b>4554-22-24</b>	<b>61,75</b>

**477**

Clé Torx Double Plate

CrV



		L mm	Part N°	€
<b>E6</b>	<b>E8</b>	130	<b>477-E6-E8</b>	<b>11,53</b>
<b>E10</b>	<b>E12</b>	144	<b>477-E10-E12</b>	<b>12,74</b>
<b>E14</b>	<b>E18</b>	180	<b>477-E14-E18</b>	<b>14,99</b>
<b>E20</b>	<b>E24</b>	220	<b>477-E20-E24</b>	<b>17,56</b>

# Clés Fixes

Clés Polygonales Contre-coudées



453

Polygonale Contre-coudée

CrV

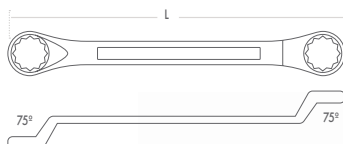

## SAE

mm	mm	L mm	Part N°	€
6	7	170	453-06-07	9,14
8	9	183	453-08-09	9,88
8	10	183	453-08-10	11,66
10	11	197	453-10-11	10,52
10	12	198	453-10-12	12,66
12	13	212	453-12-13	12,66
12	14	214	453-12-14	14,51
13	15	222	453-13-15	16,66
13	17	242	453-13-17	16,76
14	15	230	453-14-15	12,98
16	17	245	453-16-17	16,14
17	19	270	453-17-19	18,71
18	19	275	453-18-19	18,76
19	22	315	453-19-22	21,96
20	22	318	453-20-22	22,16
21	23	327	453-21-23	23,47
22	24	327	453-22-24	25,84
24	26	340	453-24-26	30,09
24	27	340	453-24-27	30,36
25	28	347	453-25-28	35,05
27	29	351	453-27-29	36,80
27	30	351	453-27-30	38,88
30	32	365	453-30-32	38,66
32	36	415	453-32-36	70,81
36	41	450	453-36-41	89,86
41	46	506	453-41-46	128,37
46	50	526	453-46-50	142,50

		L mm	Part N°	€
1/4"	5/16"	170	453-1/4-5/16	10,24
5/16"	3/8"	183	453-5/16-3/8	10,64
3/8"	7/16"	197	453-3/8-7/16	11,42
7/16"	1/2"	212	453-7/16-1/2	12,34
1/2"	9/16"	222	453-1/2-9/16	12,89
9/16"	5/8"	245	453-9/16-5/8	14,12
5/8"	11/16"	246	453-5/8-11/16	16,07
11/16"	3/4"	275	453-11/16-3/4	21,15
13/16"	7/8"	318	453-13/16-7/8	21,50
7/8"	15/16"	327	453-7/8-15/16	28,31
15/16"	1"	340	453-15/16-1	29,83
1"	1.1/8"	347	453-1-1.1/8	35,05
1.1/16"	1.1/4	365	453-1.1/16-1.1/4	38,13
1.1/8"	1.1/4	370	453-1.1/8-1.1/4	45,60

**453**

Trousse Tissu

**6**  
Pcs

CrV



350 x 330 mm

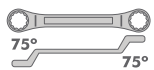

• 6x7 • 8x9 • 10x11 • 12x13 • 14x15 • 16x17

Part N°	€
453-001	77,57
453-001V *	20,52

\* Trousse Tissu Vide

**453**

Trousse Tissu

**8**  
Pcs

CrV



390 x 380 mm

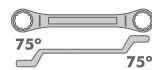

• 6x7 • 8x9 • 10x11 • 12x13 • 14x15  
• 16x17 • 18x19 • 20x22

Part N°	€
453-002	118,49
453-002V *	21,87

\* Trousse Tissu Vide

**453**

Trousse Tissu

**12**  
Pcs

CrV



620 x 480 mm

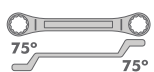

• 6x7 • 8x9 • 10x11 • 12x13 • 14x15 • 16x17  
• 18x19 • 20x22 • 21x23 • 24x27 • 25x28 • 30x32

Part N°	€
453-003	246,03
453-003V *	25,36

\* Trousse Tissu Vide

**453**

Trousse Tissu

**14**  
Pcs

CrV



620 x 600 mm

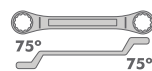

• 6x7 • 8x9 • 10x11 • 12x13 • 14x15  
• 16x17 • 18x19 • 20x22 • 21x23 • 24x26  
• 25x28 • 30x32 • 32x36 • 36x41

Part N°	€
453-004	410,18
453-004V *	26,71

\* Trousse Tissu Vide

# Clés Fixes

Jeux de Clés Polygonales Contre-coudées



453

Trousse Tissu

7 Pcs

SAE

CrV



390 x 380 mm

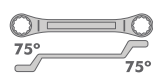

- 1/4" x 5/16"
- 5/16" x 3/8"
- 3/8" x 7/16"
- 7/16" x 1/2"
- 1/2" x 9/16"
- 5/8" x 11/16"
- 11/16" x 3/4"

Part N°	€
453-005	101,00
453-005V *	21,68

\* Trousse Tissu Vide

453

Trousse Tissu

10 Pcs

SAE

CrV



620 x 480 mm

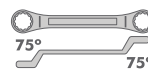

- 1/4" x 5/16"
- 5/16" x 3/8"
- 3/8" x 7/16"
- 7/16" x 1/2"
- 1/2" x 9/16"
- 9/16" x 5/8"
- 5/8" x 11/16"
- 13/16" x 7/8"
- 15/16" x 1"
- 1.1/16" x 1.1/4"

Part N°	€
453-006	183,43
453-006V *	25,02

\* Trousse Tissu Vide

453

Étui Carton

8 Pcs

CrV

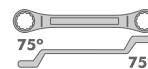

- 6x7
- 8x9
- 10x11
- 12x13
- 14x15
- 16x17
- 18x19
- 20x22

Part N°	€
453-018	120,49



Jeux de Clés Polygonales Contre-coudées et Demi-Lunes

**453**

Présentoir Plastique

**6**  
Pcs

CrV

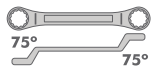

• 8x9 • 10x11 • 12x13 • 14x15 • 16x17 • 18x19

Part N°	€
453-016	89,19
450-011V *	15,44

\* Trousse Tissu Vide

**453**

Présentoir Plastique

**6**  
Pcs

CrV

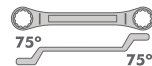

• 6x7 • 8x9 • 10x11 • 12x13 • 14x15 • 16x17

Part N°	€
453-016-2	79,57
450-011V *	15,44

\* Trousse Tissu Vide

**453**

Panneau de Mousse Modulable

**6**  
Pcs

CrV



1/3 (375 x 188 x 30 mm)

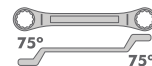

• 8x9 • 10x11 • 12x13 • 14x15 • 16x17 • 18x19

Part N°	€
453-080	93,44

Voir pour Plus d'information sur le Rangement et Panneaux de Mousse Modulables Pages:

20 • 35

Clés Demi-lune

**473**

Clé Polygonale Demi-lune

CrV



mm	mm	L mm	Part N°	€
11	13	149	473-11-13	8,40
14	17	170	473-14-17	9,44
15	16	170	473-15-16	9,46
15	17	170	473-15-17	10,71
19	22	227	473-19-22	12,12

# Clés Fixes

Clés à Tuyauter



**483**

Clé à Tuyauter

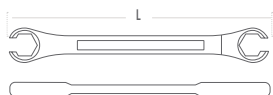

mm	L mm	Part N°	€
8 x 10	131	483-08-10	12,57
9 x 11	151	483-09-11	13,01
10 x 11	152	483-10-11	13,55
10 x 12	152	483-10-12	14,04
12 x 13	168	483-12-13	14,45
12 x 14	177	483-12-14	15,17
14 x 15	177	483-14-15	15,17
14 x 17	194	483-14-17	15,17
17 x 19	214	483-17-19	20,75
19 x 22	235	483-19-22	20,75
22 x 24	255	483-22-24	23,73
24 x 27	273	483-24-27	30,01
30 x 32	292	483-30-32	37,15

**485**

Clé à Tuyauter à Cliquet



mm	L mm	A mm	B mm	Part N°	€
10	156	32	7	485-10	25,77
11	156	32	7	485-11	25,77
12	156	32	7	485-12	25,77
13	156	32	7	485-13	25,77
14	156	32	7	485-14	25,77
17	210	35	8	485-17	31,38
19	210	37	8	485-19	31,38
22	220	41	11	485-22	34,58
24	220	41	11	485-24	37,80
27	318	49	13	485-27	53,62
32	320	54	17,8	485-32	58,94

**483**

Présentoir Plastique

6  
Pcs

CrV



Part N°	€
483-016	104,95
450-011V *	15,44

\* Présentoir Plastique Vide

**457**

Clé Mixte à Cliquet Réversible

CrV

72°<sup>5°</sup>

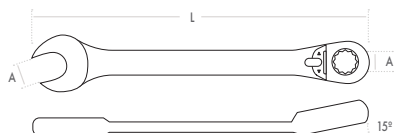

A mm	L mm	Part N°	€
6	120	457-06	22,19
7	120	457-07	22,19
8	134	457-08	22,19
9	158	457-09	23,04
10	158	457-10	24,10
11	164	457-11	24,50
12	167	457-12	25,36
13	177	457-13	25,66
14	189	457-14	29,43
15	198	457-15	30,57
16	204	457-16	32,21
17	224	457-17	33,06
18	245	457-18	34,86
19	245	457-19	36,88
20	280	457-20	45,60
21	280	457-21	40,09
22	280	457-22	46,87
23	320	457-23	55,04
24	310	457-24	52,75
25	320	457-25	68,30
26	320	457-26	80,53
27	330	457-27	73,01
28	355	457-28	93,75
29	355	457-29	95,09
30	425	457-30	86,38
31	425	457-31	107,14
32	425	457-32	102,34
33	425	457-33	112,52
36	445	457-36	210,22

# Clés à Cliquet

Jeux de Clés Mixtes à Cliquet Réversible



457

Trousse Tissu

457

Présentoir Plastique

7  
Pcs

CrV

72<sup>5°</sup>



330 x 390 mm



10 • 12 • 13 • 14 • 15 • 17 • 19

5  
Pcs

CrV

72<sup>5°</sup>



10 • 12 • 13 • 14 • 15

5  
Pcs

CrV

72<sup>5°</sup>

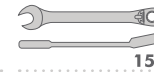

8 • 10 • 13 • 17 • 19

Part N°	€
457-001	211,31
457-001V *	19,27

\* Trousse Tissu Vide

Part N°	€
457-015	143,37
450-011V *	15,44

\* Présentoir Plastique Vide

Part N°	€
457-014	150,14
450-011V *	15,44

\* Présentoir Plastique Vide

457

Présentoir Plastique

6  
Pcs

CrV

72<sup>5°</sup>

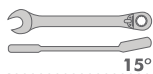

8 • 10 • 12 • 13 • 14 • 17

7  
Pcs

CrV

72<sup>5°</sup>

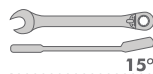

10 • 12 • 13 • 14 • 15 • 17 • 19

8  
Pcs

CrV

72<sup>5°</sup>



8 • 10 • 11 • 12 • 13 • 14 • 17 • 19

Part N°	€
457-016	168,05
450-011V *	15,44

\* Présentoir Plastique Vide

Part N°	€
457-017	213,31
455-012V *	14,75

\* Présentoir Plastique Vide

Part N°	€
457-018	229,43
450-013V *	18,01

\* Présentoir Plastique Vide

457

Présentoir Plastique

12  
Pcs

CrV

72 (5°)



Part N°	€
457-020	350,11
450-017V *	24,45

\* Présentoir Plastique Vide

457

Étui Carton

5  
Pcs

CrV

72 (5°)

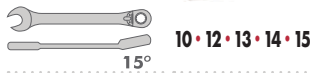

Part N°	€
457-035	143,37

6  
Pcs

CrV

72 (5°)



Part N°	€
457-036	176,43

457

Étui Carton

6  
Pcs

CrV

72 (5°)



Part N°	€
457-046	175,57

8  
Pcs

CrV

72 (5°)



Part N°	€
457-038	235,50

457

Panneau de Mousse Modulable

7  
Pcs

CrV

72 (5°)



Part N°	€
457-081	231,83

10  
Pcs



Part N°	€
457-080	241,82 *

# Clés à Cliquet

Clés Mixtes Plates à Cliquet



**4557**

Clé Mixte Plate à Cliquet

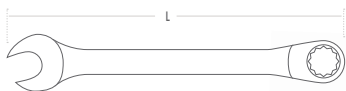

mm	L mm	Part N°	€
<b>6</b>	130	<b>4557-06</b>	<b>18,44</b>
<b>7</b>	130	<b>4557-07</b>	<b>18,57</b>
<b>8</b>	140	<b>4557-08</b>	<b>15,05</b>
<b>9</b>	150	<b>4557-09</b>	<b>15,05</b>
<b>10</b>	160	<b>4557-10</b>	<b>16,52</b>
<b>11</b>	165	<b>4557-11</b>	<b>18,08</b>
<b>12</b>	172	<b>4557-12</b>	<b>19,08</b>
<b>13</b>	177	<b>4557-13</b>	<b>20,35</b>
<b>14</b>	191	<b>4557-14</b>	<b>21,22</b>
<b>15</b>	199	<b>4557-15</b>	<b>23,01</b>
<b>16</b>	209	<b>4557-16</b>	<b>24,75</b>
<b>17</b>	225	<b>4557-17</b>	<b>25,95</b>
<b>18</b>	237	<b>4557-18</b>	<b>26,51</b>
<b>19</b>	248	<b>4557-19</b>	<b>27,05</b>
<b>20</b>	248	<b>4557-20</b>	<b>32,24</b>
<b>21</b>	289	<b>4557-21</b>	<b>37,70</b>
<b>22</b>	289	<b>4557-22</b>	<b>40,68</b>
<b>24</b>	320	<b>4557-24</b>	<b>45,56</b>
<b>27</b>	364	<b>4557-27</b>	<b>51,50</b>
<b>30</b>	423	<b>4557-30</b>	<b>55,86</b>
<b>32</b>	423	<b>4557-32</b>	<b>63,37</b>

**4557**

Présentoir Plastique

**6**  
Pcs

CrV



 • 8 • 10 • 11 • 12 • 13 • 17

Part N°	€
4557-016	123,28
450-011V *	15,44

\* Présentoir Plastique Vide

**4557**

Présentoir Plastique

**8**  
Pcs

CrV



 • 8 • 10 • 11 • 12 • 13 • 14 • 17 • 19

Part N°	€
4557-018	171,55
450-013V *	18,01

\* Présentoir Plastique Vide

**4557**

Présentoir Plastique

**10**  
Pcs

CrV



 • 8 • 9 • 10 • 11 • 12 • 13 • 14  
• 15 • 16 • 17

Part N°	€
4557-020	207,31
450-015V *	23,15

\* Présentoir Plastique Vide

**4557**

Présentoir Plastique

**12**  
Pcs

CrV



 • 8 • 9 • 10 • 11 • 12 • 13 • 14  
• 15 • 16 • 17 • 18 • 19

Part N°	€
4557-022	260,87
450-017V *	24,45

\* Présentoir Plastique Vide

# Clés à Cliquet

Clés Mixtes à Cliquet Réversible Courtes



459

Clé Mixte à Cliquet Réversible Courte

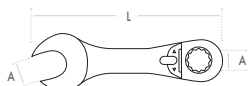

A mm	L mm	Part N°	€
<b>8</b>	93	<b>459-08</b>	<b>19,76</b>
<b>10</b>	95	<b>459-10</b>	<b>20,83</b>
<b>13</b>	106	<b>459-13</b>	<b>22,29</b>
<b>17</b>	125	<b>459-17</b>	<b>27,13</b>
<b>19</b>	138	<b>459-19</b>	<b>30,88</b>

## Jeux de Clés Mixtes à Cliquet Réversible Courtes

459

Présentoir Plastique



• 8 • 10 • 13 • 17 • 19

Part N°	€
<b>459-015</b>	<b>129,14</b>
<b>459-010V *</b>	<b>19,67</b>

\* Présentoir Plastique Vide



**475**

Clé à Cliquets 4 en 1

Cr-V

72°<sup>5°</sup>

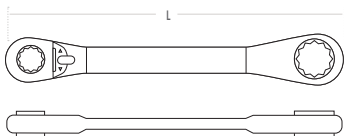

mm	mm	L mm	Part N°	€
8x10	12x13	165	475-08-13	30,53
9x11	14x15	180	475-09-15	38,07
10x13	17x19	204	475-10-19	40,38
13x15	17x19	225	475-13-19	40,38
16x17	18x19	225	475-16-19	40,36

Jeux de Clés à Cliquets 4 en 1

**475**

Trousse Tissu

**3**

Pcs

Cr-V

72°<sup>5°</sup>



220 x 330 mm



- 8x10 12x13
- 9x11 14x15
- 16x17 18x19

Part N°	€
475-001	119,21
475-001V *	14,65

\* Trousse Tissu Vide

# Clés à Cliquet

Clés Mixtes à Cliquet Flexible



458

Clé Mixte à Cliquet Flexible à Verrouillage



A mm	L mm	Part N°	€
6	136	458-06	31,50
7	136	458-07	31,50
8	136	458-08	26,65
9	150	458-09	26,65
10	158	458-10	27,92
11	175	458-11	28,92
12	175	458-12	29,70
13	185	458-13	32,47
14	193	458-14	34,68
15	215	458-15	40,66
16	215	458-16	42,27
17	231	458-17	41,01
18	249	458-18	46,17
19	249	458-19	43,72
20	280	458-20	54,15
21	280	458-21	49,83
22	280	458-22	52,03
24	310	458-24	59,35

**458**

Présentoir Plastique

**5**  
Pcs

CrV

72<sup>5°</sup>



8 • 10 • 13 • 17 • 19

Part N°	€
458-015	180,02
450-011V *	15,44

\* Présentoir Plastique Vide

**458**

Présentoir Plastique

**8**  
Pcs

CrV

72<sup>5°</sup>



8 • 10 • 11 • 12 • 13 • 14 • 17 • 19

Part N°	€
458-018	273,32
450-013V *	18,01

\* Présentoir Plastique Vide

**458**

Étui Carton

**5**  
Pcs

CrV

72<sup>5°</sup>



8 • 10 • 13 • 17 • 19

Part N°	€
458-035	180,02

**6**  
Pcs

CrV

72<sup>5°</sup>



10 • 12 • 13 • 14 • 15 • 17

Part N°	€
458-036	214,69

**8**  
Pcs

CrV

72<sup>5°</sup>



8 • 10 • 12 • 13 • 14 • 15 • 17 • 19

Part N°	€
458-038	285,06

# Clés à Cliquet

Clés à Cliquets Plates



456

Clé à Cliquets Plate

CrV

72<sup>5°</sup>

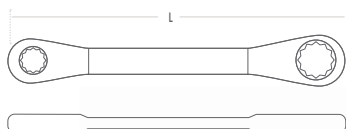

mm	mm	L mm	Part N°	€
6	7	115	456-06-07	20,11
7	8	115	456-07-08	20,11
8	9	130	456-08-09	20,11
10	11	145	456-10-11	22,30
12	13	166	456-12-13	28,17
13	17	181	456-13-17	28,32
14	15	181	456-14-15	29,26
16	18	205	456-16-18	31,67
17	19	225	456-17-19	32,56
20	22	255	456-20-22	53,37

## Jeux de Clés à Cliquets Plates

456

Présentoir Plastique

5  
Pcs

CrV

72<sup>5°</sup>



• 6x7 • 8x9 • 10x11 • 12x13 • 14x15

Part N°	€
456-015	128,20
450-011 V *	15,44

\* Présentoir Plastique Vide

456

Étui Carton

5  
Pcs

CrV

72<sup>5°</sup>



• 8x9 • 10x11 • 12x13 • 14x15 • 16x18

Part N°	€
456-035	139,76

456

Étui Carton

6  
Pcs

CrV

72<sup>5°</sup>



• 8x9 • 10x11 • 12x13 • 14x15 • 16x18 • 17x19

Part N°	€
456-036	172,32

## Clés Torx à Cliquets Plates

474

Clé Torx à Cliquets Plate

CrV

72<sup>5°</sup>



		L mm	Part N°	€
<b>E6</b>	<b>E8</b>	130	<b>474-E6-E8</b>	<b>24,77</b>
<b>E10</b>	<b>E12</b>	144	<b>474-E10-E12</b>	<b>25,89</b>
<b>E14</b>	<b>E18</b>	180	<b>474-E14-E18</b>	<b>32,01</b>
<b>E20</b>	<b>E24</b>	220	<b>474-E20-E24</b>	<b>38,37</b>

# Clés à Cliquet

Clés à Cliquets Réversibles Coudées à 15°



455

Clé à Cliquets Réversibles Coudée à 15°

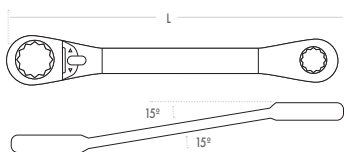

SAE

mm	mm	L mm	Part N°	€
6	7	115	455-06-07	32,70
8	9	130	455-08-09	32,70
8	10	130	455-08-10	32,70
10	11	145	455-10-11	34,60
10	12	145	455-10-12	34,60
10	13	145	455-10-13	37,08
12	13	166	455-12-13	38,19
12	14	166	455-12-14	38,19
14	15	180	455-14-15	38,63
14	17	180	455-14-17	42,50
16	17	205	455-16-17	42,50
16	18	205	455-16-18	42,50
17	19	225	455-17-19	44,23

		L mm	Part N°	€
1/4"	5/16"	115	455-1/4-5/16	31,13
3/8"	7/16"	145	455-3/8-7/16	33,44
1/2"	9/16"	166	455-1/2-9/16	37,16

455

Trousse Tissu



300 x 390 mm

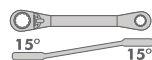

• 8x9 • 10x11 • 12x13 • 14x15 • 16x18 • 17x19

Part N°	€
455-001	237,10
455-001V *	19,62

\* Trousse Tissu Vide

455

Étui Carton

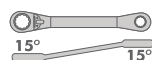

• 8x9 • 10x11 • 12x13 • 14x15 • 16x18

Part N°	€
455-035	194,87

455

Étui Carton

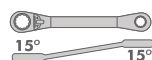

• 8x9 • 10x11 • 12x13 • 14x15 • 16x18 • 17x19

Part N°	€
455-036	239,10

**455** Présentoir Plastique

**5**  
Pcs CrV 72° 15°

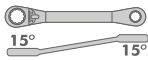

• 8x9 • 10x11 • 12x13 • 14x15 • 16x18

Part N°	€
455-015	194,87
450-011V *	15,44

\* Présentoir Plastique Vide

**455** Présentoir Plastique

**7**  
Pcs CrV 72° 15°

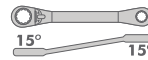

• 6x7 • 8x9 • 10x11 • 12x13 • 14x15 • 16x18 • 17x19

Part N°	€
455-017	271,80
455-012V *	14,75

\* Présentoir Plastique Vide

**455** Panneau de Mousse Modulaire

**9**  
Pcs CrV 72° 15°



1/3 (375 x 188 x 30 mm)

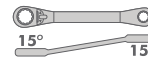

• 8x9 • 10x11 • 12x13 • 14x15 • 16x18 • 17x19



• 1/4" • 3/8" • 1/2"

Part N°	€
455-080	267,61

Voir pour Plus d'information de Panneaux Modulaires

p. 20 • 35

Accessoires pour Clés à Cliquet

**476** Adaptateur pour Douilles

CrV



□	○ mm	Part N°	€
1/4"	10	476-1/4-10	7,12
3/8"	13	476-3/8-13	7,90
1/2"	19	476-1/2-19	9,24
3/4"	32	476-3/4-32	18,43

**476** Adaptateur pour Embouts de Vissage

CrV



□	○ mm	Part N°	€
1/4"	10	476-1/4P-10	2,68
5/16"	13	476-5/16P-13	4,46
10 mm	19	476-10P-19	5,42

# Clés Fixes

## Clés à Béquille



461

Clé à Béquille Double

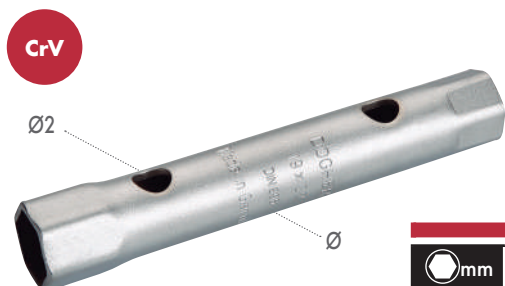

Tige

mm	mm	L mm	Ø mm	Ø2 mm	Part N°	€	L mm	Ø mm	Part N°	€
6	7	110	12	7	461-06-07	4,77	131,5	6,5	460-04	4,86
8	9	110	14	7	461-08-09	5,66				
8	10	120	13	6	461-08-10	5,89	131,5	5,5	460-03	3,48
9	10	120	13	6	461-09-10	6,04				
10	11	130	17	8	461-10-11	6,15	131,5	7,5	460-05	6,11
10	13	140	15	8	461-10-13	6,18				
11	13	140	15	8	461-11-13	6,25				
12	13	140	17	8	461-12-13	6,39				
12	14	143	17	8	461-12-14	6,85	131,5	9,5	460-06	7,36
13	14	144	17	8	461-13-14	6,85				
13	15	142	17	8	461-13-15	6,85	131,5	7,5	460-05	6,11
13	17	149	20	10	461-13-17	6,85				
14	15	140	19	8	461-14-15	6,47	131,5	7,5	460-05	6,11
14	17	149	20	10	461-14-17	7,30	131,5	9,5	460-06	7,36
16	17	150	21	8	461-16-17	7,18	131,5	7,5	460-05	6,11
17	19	157	24	10	461-17-19	8,47	131,5	9,5	460-07	8,61
18	19	160	22	8	461-18-19	8,59	131,5	7,5	460-05	6,11
19	22	169	26	12	461-19-22	9,96	131,5	11,5	460-07	8,61
20	22	170	25,5	8	461-20-22	9,69	131,5	7,5	460-05	6,11
21	23	170	25,5	8	461-21-23	10,86				
22	24	184	33	14	461-22-24	12,26	131,5	12,5	460-08	10,84
24	26	190	32	8	461-24-26	11,74	131,5	7,5	460-05	6,11
24	27	183	30	14	461-24-27	14,39	131,5	12,5	460-08	10,84
25	28	190	32	8	461-25-28	14,19	131,5	7,5	460-05	6,11
27	29	195	32	8	461-27-29	15,61				
27	30	198	35	18	461-27-30	16,65	250	13,6	543-015	15,88
27	32	196	35	18	461-27-32	16,65	250	13,6	543-015	15,88
30	32	210	32	8	461-30-32	15,61	131,5	7,5	460-05	6,11
36	38	165	42,5	10	461-36-38	18,46	131,5	9,5	460-06	7,36
36	41	221	45	18	461-36-41	36,03	500	18	460-10	26,36
41	46	237	50	18	461-41-46	43,16				
46	50	238	54	18	461-46-50	65,07				
50	55	238	60	18	461-50-55	137,92				

• Autres tiges compatibles:

L mm	Ø mm	Part N°	€
115	7,5	509-015	7,77
200	11	524-015	11,73
250	13,6	543-015	15,88



**461**

Trousse Tissu

**8**

Pcs

CrV



380 x 400 mm



- 6x7
- 8x9
- 10x11
- 12x13
- 14x15
- 16x17
- 18x19
- 20x22

Part N°	€
<b>461-001</b>	<b>61,15</b>
<b>461-001V *</b>	<b>20,74</b>

\* Trousse Tissu Vide

**461**

Trousse Tissu

**12**

Pcs

CrV



520 x 390 mm



- 6x7
- 8x9
- 10x11
- 12x13
- 14x15
- 16x17
- 18x19
- 20x22
- 21x23
- 24x26
- 25x28
- 30x32

Part N°	€
<b>461-002</b>	<b>117,55</b>
<b>461-002V *</b>	<b>22,77</b>

\* Trousse Tissu Vide

# Clés Fixes

Clés à Béquille et Tige



460

Clé à Béquille Double Forcée

CrV



mm	mm	L mm	mm	Part N°	€
6	7	105	8	460-06-07	13,70
8	9	110	8,6	460-08-09	13,88
10	11	120	11	460-10-11	14,69
12	13	140	13	460-12-13	17,23
14	15	145	14	460-14-15	19,30
16	17	155	16	460-16-17	22,48
18	19	165	18	460-18-19	26,87
20	22	170	20	460-20-22	30,64
21	23	185	21	460-21-23	34,10
24	26	190	24	460-24-26	40,40
25	28	205	25	460-25-28	46,37
27	29	210	27	460-27-29	57,57
30	32	210	30	460-30-32	62,32

460

Tige pour Clé à Béquille Double Forcée



Ø mm	mm	mm	Part N°	€
2,5	6	7	460-01	2,09
	8	9		
4,5	10	11	460-02	3,20
	12	13		
5,5	14	15	460-03	3,48
	16	17		
6,5	18	19	460-04	4,86
	20	22		
7,5	21	23	460-05	6,11
	24	26		
9,5	25	28	460-06	7,36
	27	29		
11,5	30	32	460-07	8,61
	30	32		
12,5	30	32	460-08	10,84
	30	32		

## Jeux de Clés à Béquille Double Forcée

460

Panneau de Mousse Modulaire

8  
Pcs

CrV



1/4 (375 x 140 x 30 mm)

- 6x7 • 8x9 • 10x11 • 12x13 • 14x15
- 16x17 • 18x19 • 20x22

Part N°	€
460-080	168,04

Voir pour Plus d'information de Panneaux Modulaires

p. 20 • 35

**460**

Trousse Tissu

**6**  
Pcs

CrV



330 x 350 mm



• 6x7 • 8x9 • 10x11 • 12x13 • 14x15 • 16x17

Part N°	€
460-001	107,53
460-001V *	18,36

\* Trousse Tissu Vide

**460**

Trousse Tissu

**8**  
Pcs

CrV



430 x 380 mm



• 6x7 • 8x9 • 10x11 • 12x13 • 14x15 • 16x17  
• 18x19 • 20x22

Part N°	€
460-002	165,04
460-002V *	20,17

\* Trousse Tissu Vide

**460**

Trousse Tissu

**10**  
Pcs

CrV



480 x 380 mm



• 6x7 • 8x9 • 10x11 • 12x13 • 14x15 • 16x17  
• 18x19 • 20x22 • 21x23 • 24x26

Part N°	€
460-003	241,54
460-003V *	20,17

\* Trousse Tissu Vide

**460**

Trousse Tissu

**12**  
Pcs

CrV



520 x 390 mm



• 6x7 • 8x9 • 10x11 • 12x13 • 14x15 • 16x17  
• 18x19 • 20x22 • 21x23 • 24x26 • 25x28 • 30x32

Part N°	€
460-004	351,23
460-004V *	22,16

\* Trousse Tissu Vide

# Clés Fixes

Clés Courbées



462

Clé à Pipe Débouchée Forcée 6 Pans x 6 Pans



mm	L mm	Part N°	€
6	110	462-06	7,60
7	114	462-07	7,88
8	120	462-08	8,34
9	125	462-09	8,54
10	131	462-10	9,29
11	137	462-11	9,62
12	144	462-12	10,58
13	153	462-13	10,70
14	160	462-14	12,84
15	174	462-15	13,83
16	185	462-16	14,67
17	197	462-17	15,54
18	211	462-18	16,74
19	218	462-19	17,41
20	222	462-20	17,56
21	231	462-21	20,00
22	247	462-22	20,80
23	255	462-23	23,35
24	266	462-24	24,48
25	278	462-25	26,47
26	289	462-26	32,28
27	299	462-27	35,24
28	310	462-28	39,70
29	319	462-29	40,16
30	332	462-30	49,93
32	353	462-32	52,11

462

Panneau Clés à Pipe Débouchées Forcées 6 Pans x 6 Pans

11  
Pcs

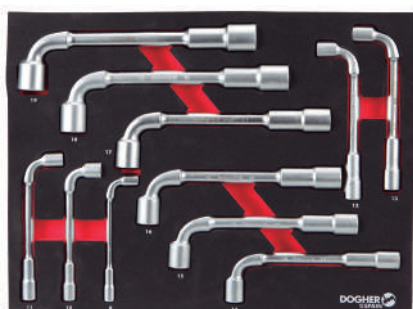

Part N°	€
462-080	159,56

1/2 (375 x 280 x 30)

Voir pour Plus d'information de Panneaux Modulaires

p. 20 • 35

**462**

Jeu de Clés à Pipe Débouchées  
Forgées 6x6

**5**  
Pcs

CrV



Part N°	€
462-010	62,70

**462**

Jeu de Clés à Pipe Débouchées  
Forgées 6x6

**10**  
Pcs

CrV



Part N°	€
462-011	118,05

**462**

Trousse Tissu

**6**  
Pcs

CrV



190 x 280 mm



Part N°	€
462-001	81,39
462-001V *	18,36

\* Trousse Tissu Vide

**462**

Trousse Tissu

**10**  
Pcs

CrV



Part N°	€
462-003	126,28
462-003V *	19,02

\* Trousse Tissu Vide

# Clés Fixes

Clés Courbées



467

Clé à Douilles Articulées

CrV



mm	mm	L mm	Part N°	€
6	7	195	467-06-07	17,18
8	9	195	467-08-09	18,45
10	11	210	467-10-11	19,37
12	13	225	467-12-13	20,99
14	15	245	467-14-15	23,60
16	17	260	467-16-17	26,03
18	19	275	467-18-19	29,96
20	22	300	467-20-22	38,14
21	23	300	467-21-23	43,59
24	27	325	467-24-27	44,06

467

Panneau de Mousse Modulable

6 Pcs

CrV



1/3 (375 x 188 x 30 mm)

• 8x9 • 10x11 • 12x13 • 14x15 • 16x17 • 18x19

Part N°	€
467-080	150,90

Pour Plus d'information sur le Rangement et  
Panneaux de Mousse Modulables Voir Pages:

20 • 35

465

Clé Pour Roue

CrV

1/2"



mm	L mm	Part N°	€
1/2"	300	465-1/2-300	14,56

CrV

3/4"



mm	L mm	Part N°	€
3/4"	300	465-3/4-300	23,12
3/4"	450	465-3/4-450	30,85

467

Trousse Tissu

7 Pcs

CrV



330 x 390 mm

• 8x9 • 10x11 • 12x13 • 14x15 • 16x17  
• 18x19 • 20x22

Part N°	€
467-001	182,79
467-001V *	20,36

\* Trousse Tissu Vide

**466**

Clé en Croix

CrV

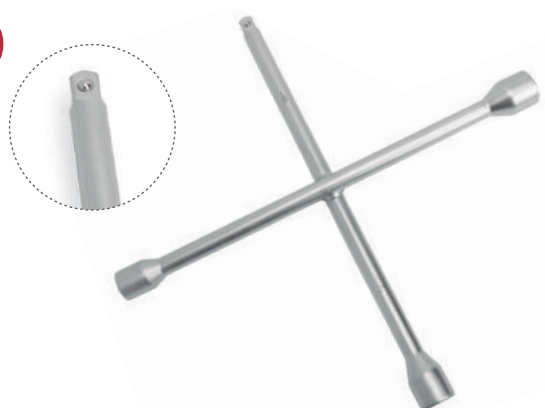

mm	mm	L mm	Part N°	€
1/2"	17x19x22	375	466-1/2-375	32,04
3/4"	24x27x32	625	466-3/4-625	90,72

**468**

Clé à Bougie Articulée

CrV



mm	L mm	Part N°	€
16	300	468-16-300	29,22
18	300	468-18-300	30,12
21	300	468-21-300	30,36

**469**

Clé à Béquille Articulée

CrV

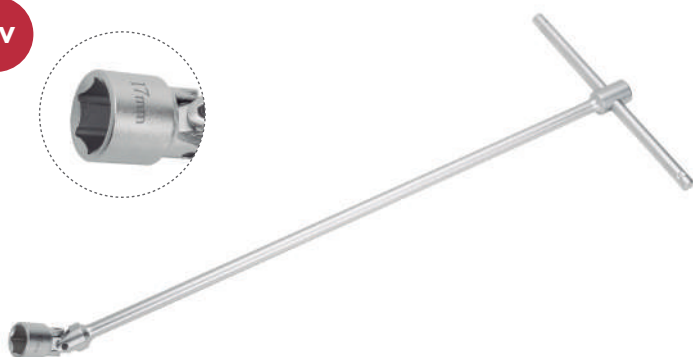

mm	L mm	Part N°	€
6	390	469-06-390	30,62
8	390	469-08-390	30,62
10	500	469-10-500	34,11
12	500	469-12-500	34,11
13	500	469-13-500	34,11
17	500	469-17-500	38,61
19	500	469-19-500	42,70

# Clés Fixes

## Clés Universelles



**470**

Clé Universelle : Eau, Gaz et Electricité

6-8 mm

PH2

7 mm

9 mm

9 mm

Adapt. 1/4"

Part N°	€
<b>470-001</b>	<b>20,78</b>



• Fabriqué en Zamak. Pour les installations techniques dans les bâtiments, système d'air conditionné et de ventilation, valves d'arrêt, tableaux électriques...

**EXP**

12 Clés Universelles :  
Eau, Gaz et Electricité



**470-001 (x12)**

Part N°	€
<b>470-001J</b>	<b>249,36</b>

230 x 210 x 155 mm

**470**

Clé Universelle : Chauffage et Climatisation

6-8 mm

PH2

Adapt. 1/4"

10 mm

9 mm

7 mm



Part N°	€
<b>470-002</b>	<b>21,17</b>

• Fabriqué en Zamak. Pour les installations techniques dans les bâtiments, système d'air conditionné et de ventilation, valves d'arrêt, tableaux électriques...



Clés à Crochet

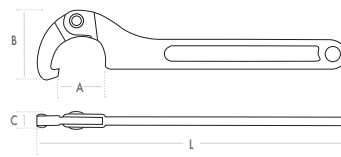

**471**

Clé à Crochet

CrV



 mm	L mm	Part N°	€
<b>13~35</b>	168	<b>471-13-35</b>	<b>27,37</b>
<b>35~50</b>	202	<b>471-35-50</b>	<b>33,14</b>
<b>50~80</b>	280	<b>471-50-80</b>	<b>49,78</b>
<b>80~120</b>	345	<b>471-80-120</b>	<b>64,52</b>
<b>120~180</b>	492	<b>471-120-180</b>	<b>88,73</b>

**472**

Clé à Ergot Avec Téton Interchangeable

CrV



 mm	L mm	Part N°	€
<b>13~35</b>	168	<b>472-13-35</b>	<b>33,08</b>
<b>35~50</b>	202	<b>472-35-50</b>	<b>36,57</b>
<b>50~80</b>	280	<b>472-50-80</b>	<b>51,22</b>
<b>80~120</b>	345	<b>472-80-120</b>	<b>68,75</b>
<b>120~180</b>	492	<b>472-120-180</b>	<b>92,01</b>

**472**

Téton de Rechange

CrV



 mm	Ø mm	Part N°	€
<b>13~35</b>	3	<b>472-0</b>	<b>2,97</b>
<b>35~50</b>	4	<b>472-1</b>	<b>3,94</b>
<b>50~80</b>	5	<b>472-2</b>	<b>5,53</b>
<b>80~120</b>	6	<b>472-3</b>	<b>7,05</b>
<b>120~180</b>	8	<b>472-4</b>	<b>9,21</b>

**471**

Clé à Crochet

CrV



 mm	L poignée	Part N°	€
<b>120~325</b>	600	<b>471-120-325</b>	<b>364,10</b>

**472**

Jeu de Clés à Téton Réglable



 mm	Part N°	€
<b>20~100</b>	<b>472-001</b>	<b>156,83</b>

# Clés Fixes

Clés pour Carter et Démonte-Pneus



**482**

Clé Pour Bouchon de Carter

- CrV
- 8 mm
- 10 mm

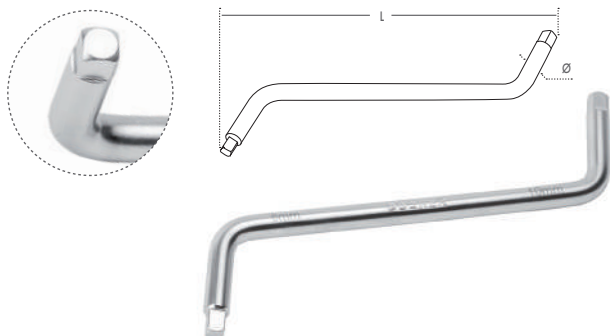

mm	mm	L mm	Ø mm	Part N°	€
8	10	255	12	482-001	10,74

• Pour Bouchons de carter d'huile et Boîte de vitesse pour Citroën, Peugeot, Renault, Volvo...

**482**

Clé Renforcée Pour Bouchon de Carter

- CrV
- 8 mm
- 10 mm

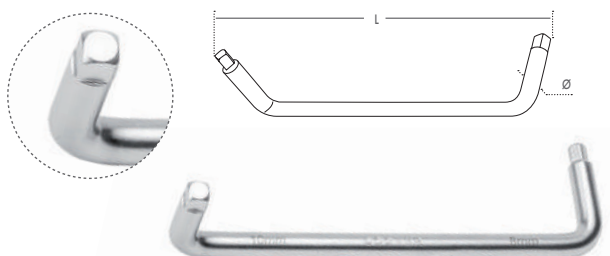

mm	mm	L mm	Ø mm	Part N°	€
8	10	235	13	482-002	17,22

• Pour Bouchons de carter d'huile et Boîte de vitesse pour Citroën, Peugeot, Renault, Volvo...

**482**

Clé Renforcée avec Douille Pour Bouchon de Carter

- CrV
- 8 mm
- 11 mm

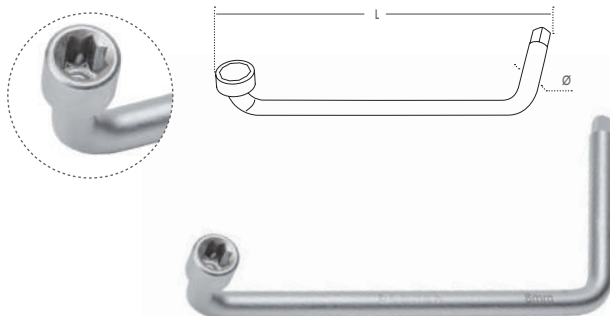

mm	mm	L mm	Ø mm	Part N°	€
8	11	250	12	482-003	19,68

• Pour Bouchons de carter d'huile et Boîte de vitesse pour Citroën, Peugeot, Renault, Volvo...

**480**

Démonte-Pneus



L mm	Part N°	€
215	480-215	8,02
350	480-350	13,86
380	480-380	22,51
500	480-500	23,69

**466**

Démonte-Pneus



mm	Part N°	€
17	466-17	16,13
19	466-19	17,18
21	466-21	19,12
23	466-23	20,50

**481**

Clé à Filtre Auto-Réglable 3 Positions



mm	Part N°	€
85~115	481-85-115	29,01

**481**

Clé à Filtre à Bande Métallique



mm	Part N°	€
65~105	481-65-105	24,80
110~165	481-110-165	26,37

• Retirer la vis de la base giratoire pour remplacer le ruban.

**481**

Bande Métallique de Rechange



mm	Part N°	€
65~105	481-65-105R	7,34
110~165	481-110-165R	8,21

Apte pour  
481-65-105 / 481-110-165

**480**

Jeu d'outils pour Intérieur



**11**  
Pcs



- Outils permettant de retirer facilement les panneaux intérieurs, les tableaux de bord, les garnitures, les moulures et autres accessoires à l'intérieur des voitures.
- Fabriqué en plastique très résistant pour une longue durée de vie.
- Évite d'endommager les surfaces et les pièces plus souples.



Part N°	€
480-011	42,26

## Clés Fixes

Clés à Filtre et Cloches pour Filtres



**481**

Clé à Filtre à Chaîne

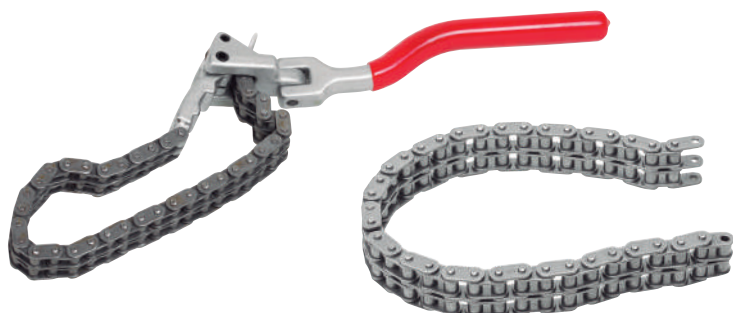

L mm (Chaîne)	Ø mm	Part N°	€
<b>350</b>	60-105	<b>481-010</b>	<b>81,49</b>
<b>520</b>	60-160	<b>481-011</b>	<b>117,71</b>

Chaîne de Rechange

<b>481-010R</b>	<b>36,84</b>
<b>481-011R</b>	<b>44,23</b>

**481**

Clé à Filtre à Sangle



L mm (Sangle)	Ø mm	Part N°	€
<b>580</b>	60-140	<b>481-020</b>	<b>33,79</b>
<b>840</b>	60-265	<b>481-021</b>	<b>62,63</b>

Sangle de Rechange

<b>481-020R</b>	<b>16,70</b>
<b>481-021R</b>	<b>20,99</b>

**481**

Coffret de Cloches pour Filtres à Huile

**30**  
Pcs



Part N°	€
<b>481-001</b>	<b>211,74</b>

Inclut:

- 28 cloches
- 1 clé à filtre 3 mors ajustable 65-120 mm
- 1 adaptateur réducteur 1/2" à 3/8"

**481**

Cloches pour Filtres à Huile

CrV

DIN7444



	Ø mm	Part N°	€	
<b>14</b>	65	<b>481-101</b>	<b>15,39</b>	Daihatsu - Toyota - Nissan - Fiat
<b>6</b>	66	<b>481-102</b>	<b>15,39</b>	Fiat Punto 1.2 - Renault Clio 1.2 - Rapid - Twingo
<b>14</b>	65-67	<b>481-103</b>	<b>15,39</b>	Daihatsu - Toyota - Nissan - Fiat
<b>14</b>	68	<b>481-104</b>	<b>15,39</b>	Mazda - Ford - Subaru
<b>14</b>	73	<b>481-105</b>	<b>15,39</b>	Toyota - Lexus - Alfa Romeo
<b>15</b>	74	<b>481-106</b>	<b>15,39</b>	Audi - General Motors - Rover - Chrysler
<b>15</b>	74-76	<b>481-107</b>	<b>15,39</b>	Ford - Opel - VW, Audi - Mercedes-Benz - Chrysler
<b>15</b>	75-77	<b>481-108</b>	<b>15,39</b>	VW - Audi - Isuzu - Mercedes-Benz - Ford - Opel
<b>8</b>	76	<b>481-109</b>	<b>15,39</b>	Fiat Marea - Lancia Delta
<b>12</b>	76	<b>481-110</b>	<b>15,39</b>	Fiat - Mercedes-Benz - Renault
<b>14</b>	76	<b>481-111</b>	<b>15,39</b>	VW - Porsche - Mercedes-Benz - BMW, Audi - Opel
<b>30</b>	76	<b>481-112</b>	<b>15,39</b>	Ford - Motorcraft FL400A
<b>15</b>	78	<b>481-113</b>	<b>15,39</b>	Nissan - Ford - Toyota - Honda
<b>15</b>	80	<b>481-114</b>	<b>15,39</b>	Nissan - Honda - Opel - Mazda - Subaru - Toyota
<b>15</b>	80-82	<b>481-115</b>	<b>15,39</b>	Subaru - Toyota - Honda - Nissan - Mazda - Acura
<b>16</b>	86	<b>481-116</b>	<b>15,39</b>	Volvo
<b>18</b>	86	<b>481-117</b>	<b>15,39</b>	VW - Audi - Peugeot - Citroen - Renault
<b>18</b>	90	<b>481-118</b>	<b>15,39</b>	Honda - Mitsubishi - Isuzu - Subaru - Mazda
<b>10</b>	92	<b>481-119</b>	<b>15,39</b>	Fiat - Lancia
<b>15</b>	93	<b>481-120</b>	<b>15,39</b>	Mazda - Volvo - Mitsubishi - Nissan - Honda
<b>36</b>	93	<b>481-121</b>	<b>15,39</b>	Ford - Motorcraft FLINFLA 1B - FL3001 - FL320
<b>45</b>	93	<b>481-122</b>	<b>15,39</b>	VW - Audi
<b>15</b>	95	<b>481-123</b>	<b>15,39</b>	Toyota - Alfa Romeo - Ford - General Motors - Chrysler
<b>18</b>	96	<b>481-124</b>	<b>15,39</b>	Audi - VW - Renault
<b>15</b>	100	<b>481-125</b>	<b>15,39</b>	Isuzu - Mitsubishi
<b>15</b>	106	<b>481-126</b>	<b>15,39</b>	Fiat - Scania - MAN
<b>15</b>	108	<b>481-127</b>	<b>15,39</b>	Volvo Diesel C70 - S70 - N70 - 850 TDI
<b>18</b>	108	<b>481-128</b>	<b>15,39</b>	Daihatsu - Toyota - Nissan - Fiat

**905**

Clé à Filtre 3 Mors Ajustables

3/8"



Ø mm	Part N°	€
<b>65-120</b>	<b>905-020</b>	<b>20,72</b>

# Clés Fixes

Clés à Frapper



452

Clé Polygonale à Frapper

CrV

DIN7444



mm	L mm	Part N°	€
17	146	452-17	30,98
19	147	452-19	31,41
22	152	452-22	32,15
24	163	452-24	32,42
27	180	452-27	35,89
30	190	452-30	40,82
32	190	452-32	43,90
36	205	452-36	50,67
41	230	452-41	66,59
46	240	452-46	75,16
50	253	452-50	88,34
55	266	452-55	101,05
60	280	452-60	106,53
65	300	452-65	139,17
70	330	452-70	165,05
75	330	452-75	177,26
80	360	452-80	235,80
85	360	452-85	276,30
90	390	452-90	355,51
95	390	452-95	380,04
100	420	452-100	434,19
105	420	452-105	564,45
110	450	452-110	619,36
115	450	452-115	695,27
120	480	452-120	855,10
125	480	452-125	1.106,21
130	520	452-130	1.203,09
135	520	452-135	1.240,98
140	520	452-140	1.484,79
145	580	452-145	1.954,05
150	580	452-150	2.057,02
155	580	452-155	2.233,39
160	650	452-160	2.366,81
165	650	452-165	2.514,24
170	650	452-170	2.523,26
175	650	452-175	2.706,69
180	650	452-180	2.905,17

**478**

Clé à Fourche à Frapper

**DIN133**

CrV



mm	L mm	Part N°	€
22	133	478-22	28,48
24	177	478-24	30,29
27	180	478-27	31,10
30	190	478-30	36,15
32	190	478-32	38,36
36	215	478-36	49,85
41	235	478-41	60,08
46	255	478-46	80,91
50	275	478-50	93,77
55	300	478-55	109,43
60	320	478-60	121,59
65	342	478-65	152,32
70	375	478-70	189,03
75	375	478-75	210,16
80	408	478-80	264,34
85	408	478-85	277,73
90	445	478-90	345,58
95	445	478-95	380,69
100	485	478-100	562,42
105	485	478-105	611,81
110	510	478-110	685,76
115	510	478-115	802,49
120	545	478-120	851,14
125	545	478-125	900,12

**479**

Clé à Fourche Unique

**DIN894**

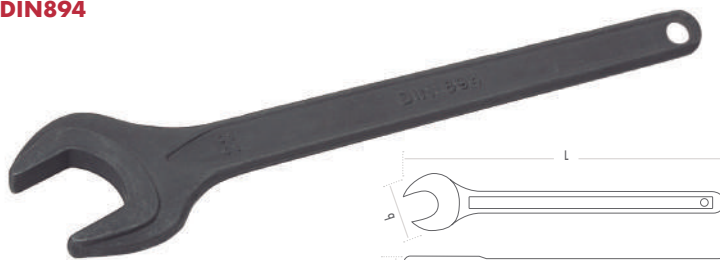

mm	L mm	a mm	b mm	Part N°	€
07	78	3,2	15	479-07	3,38
08	94	3,7	18	479-08	3,38
09	100	3,7	20	479-09	3,38
10	106	4,5	22	479-10	3,38
11	112	4,8	24	479-11	3,48
12	125	4,3	26	479-12	3,48
13	125	5,1	27	479-13	3,48
14	135	5,3	30	479-14	4,06
15	140	5,5	32	479-15	4,21
16	156	5,3	33	479-16	4,21
17	158	5,8	35	479-17	4,21
18	171	5,4	37	479-18	4,50
19	171	6,5	39	479-19	4,68
22	190	6,9	44	479-22	6,52
24	208	8,3	49	479-24	7,84
27	235	8,9	55	479-27	8,98
30	262	9,6	61	479-30	10,52
32	274	10,2	64	479-32	11,89
34	284	10,1	69	479-34	19,79
36	295	11,3	72	479-36	21,41
38	295	11,6	77	479-38	24,11
41	335	12,3	83	479-41	24,56
46	370	12,6	91	479-46	27,80
50	400	13,5	100	479-50	34,80
55	445	15,8	113	479-55	41,12
60	475	16,0	121	479-60	57,94
65	510	17,2	132	479-65	69,52
70	560	19,8	142	479-70	81,18
75	585	19,6	152	479-75	139,85
80	635	22,1	160	479-80	165,05
85	675	23,4	175	479-85	201,46
90	745	22,1	190	479-90	225,35
95	855	26,7	205	479-95	342,83
100	1000	26,1	205	479-100	349,42

## Clés Fixes

Clés Polygonales Contre-Coudées Gros Efforts



484

Clé Polygonale Contre-Coudée Gros Efforts

CrV



mm	Part N°	€
24	484-24	61,66
27	484-27	61,66
30	484-30	61,66
32	484-32	65,50
36	484-36	74,84
38	484-38	90,10
41	484-41	100,00
43	484-43	107,46
46	484-46	120,40
50	484-50	134,26
55	484-55	150,27
60	484-60	170,66
65	484-65	192,31
70	484-70	209,63
75	484-75	288,36
80	484-80	316,75
85	484-85	340,82
90	484-90	537,11
95	484-95	582,14
100	484-100	615,00
105	484-105	647,86
110	484-110	852,75
115	484-115	919,09

484

Rallonge pour Clé Polygonale Contre-Coudée Gros Efforts

CrV



L mm	Ø mm	g	Part N°	€
350	32	960	484-001	55,67
580	32	1.600	484-002	74,99
850	32	2.300	484-003	120,09



Clés isolées VDE selon la norme DIN IEC 60900 testées à 10000VCA et certifiées pour 1000VCA

### 4581

#### Clé à Fourche Isolée

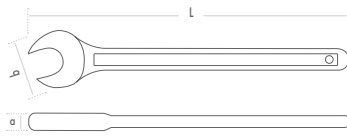

A mm	L mm	a mm	b mm	Part N°	€
6	89	7	22	4581-06	25,75
7	89	7	24	4581-07	25,75
8	99	7	25	4581-08	25,75
9	99	7	28	4581-09	25,75
10	108	8	29	4581-10	27,91
11	108	8	31	4581-11	27,91
12	129	8	33	4581-12	29,49
13	134	10	34	4581-13	31,26
14	144	10	37	4581-14	33,85
15	148	11	40	4581-15	33,85
16	158	11	42	4581-16	35,96
17	158	12	44	4581-17	35,96
18	173	12	44	4581-18	37,29
19	173	12	47	4581-19	37,29
21	194	12	50	4581-21	39,23
22	194	13	54	4581-22	42,76
24	224	13	56	4581-24	48,21
27	250	14	61	4581-27	58,61
30	287	14	66	4581-30	62,99
32	307	16	70	4581-32	63,85

### 4583

#### Clé Polygonale Isolée

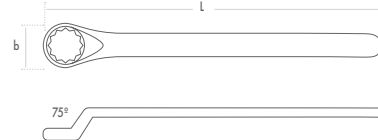

	L mm	b mm	Part N°	€
6	151	16	4583-06	33,56
7	153	17	4583-07	33,56
8	157	18	4583-08	33,56
9	157	20	4583-09	33,56
10	172	21	4583-10	34,42
11	173	23	4583-11	34,42
12	194	23	4583-12	35,96
13	194	26	4583-13	42,95
14	207	26	4583-14	44,89
15	207	27	4583-15	46,44
16	218	30	4583-16	48,21
17	220	31	4583-17	48,21
18	234	32	4583-18	51,03
19	234	34	4583-19	51,03
21	248	38	4583-21	55,34
22	250	38	4583-22	58,61
24	270	40	4583-24	65,35

### 4581

#### Trousse Tissu

14  
Pcs

CrV



650 x 440 mm



8 • 9 • 10 • 11 • 12 • 13 • 14  
17 • 19 • 22 • 24 • 27 • 30 • 32

Part N°	€
4581-002	551,59
451-002V *	24,40

\* Trousse Tissu Vide

# Clés à Molette

Clés à Molette Isolées



495

Clé à Molette Isolée

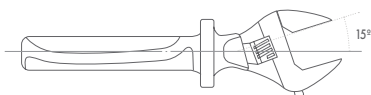

Manche Bi-matière

L mm	L "	mm	Part N°	€
200	8	25	495-200	45,30
250	10	33	495-250	53,05

497

Clé à Molette Latérale Isolée

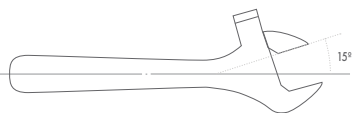

L mm	L "	mm	Part N°	€
200	8	28	497-200	161,52
250	10	33	497-250	180,62
300	12	38	497-300	196,76