

DOGHER

TOOLS

Making Solutions



476



477



482



483



484



486



488



491



492



493



495
496

Outils Divers

900

Outils Divers

Casse-Boulons et Extracteur



901

Casse-Boulons Professionnel



mm	Part N°	€
3 ~ 12 mm	901-03-12	34,91
12 ~ 16 mm	901-12-16	40,78
16 ~ 22 mm	901-16-22	50,41



- Enlève les boulons bloqués sans abimer le filetage.
- Placez le casse-boulons comme indiqué sur le schéma pour une utilisation correcte de l'outil.

905

Extracteur avec Goupilles Filetées M3-M4-M5-M6-M8-M10



Part N°	€
905-150	161,46

M12x1,5

905

Tête de Remplacement



Filetage	Part N°	€
M3	905-103	13,89
M4	905-104	13,89
M5	905-105	13,89
M6	905-106	13,89
M8	905-108	13,89
M10	905-110	13,89

902

Extracteur à 2 Griffes Réversible

CrV

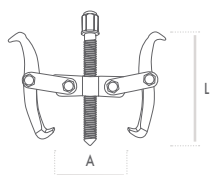

L mm	L"	A min-A max	Filetage	Tens. max.(KN)	Part N°	€
75	3"	15-80	Tr 12x2	11	902-075	43,28
100	4"	20-110	Tr 14x2,5	18	902-100	50,96
150	6"	25-160	Tr 17x2,5	30	902-150	68,28
200	8"	30-210	Tr 21x2,5	50	902-200	124,48
300	12"	50-310	Tr 30x4	98	902-300	268,33

903

Extracteur à 3 Griffes Réversible

CrV

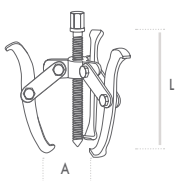

L mm	L"	A min-A max	Filetage	Tens. max.(KN)	Part N°	€
75	3"	15-80	Tr 12x2	16	903-075	51,94
100	4"	20-110	Tr 14x2,5	26	903-100	61,17
150	6"	25-160	Tr 17x2,5	44	903-150	81,96
200	8"	30-210	Tr 21x2,5	70	903-200	149,39
300	12"	50-310	Tr 30x4	110	903-300	393,17

900/902/903

Pièces de Rechange pour Extracteur

L mm	L"	Griffe		Arbre		Apte pour	L mm	L"	Corps		Apte pour
		Part N°	€/u.	Part N°	€				Part N°	€	
75	3"	900-075G	21,65	900-075H	12,99	902-075 / 903-075	75	3"	902-075C	8,66	902-075
100	4"	900-100G	25,49	900-100H	15,29	902-100 / 903-100	100	4"	902-100C	10,20	902-100
150	6"	900-150G	27,32	900-150H	20,48	902-150 / 903-150	150	6"	902-150C	13,65	902-150
200	8"	900-200G	43,57	900-200H	37,34	902-200 / 903-200	200	8"	902-200C	24,90	902-200
300	12"	900-300G	107,33	900-300H	53,67	902-300 / 903-300	300	12"	902-300C	48,30	902-300

L mm	L"	Corps		Apte pour
		Part N°	€	
75	3"	903-075C	10,39	903-075
100	4"	903-100C	12,23	903-100
150	6"	903-150C	16,39	903-150
200	8"	903-200C	29,87	903-200
300	12"	903-300C	78,63	903-300

Outils Divers

Extracteurs



904

Extracteur Universel à 2 Griffes Réversible

CrV

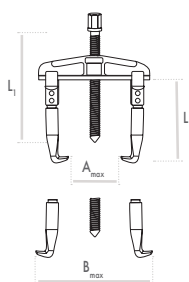

A min-A max	B min-Bmax	L	Filetage	L ₁	Tens. max.(KN)	Part N°	€
30-90	70-130	100	M14x1,5	130	30	904-90-100	76,59
35-130	80-180	100	M14x1,5	130	30	904-130-100	77,90
40-160	105-220	150	M20x2	210	42	904-160-150	129,17
40-200	120-270	150	M20x2	210	42	904-200-150	177,87
60-250	160-330	205	M27x2	280	60	904-250-200	324,56
60-350	160-420	205	M27x2	280	60	904-350-200	360,04
90-520	195-600	205	M27x2	280	60	904-520-200	584,27

904

L mm	L"	Griffe		Arbre		Apte pour
		Part N°	€/u.	Part N°	€	
100	4"	904-001G	30,63	904-001H	22,97	904-90-100 / 904-130-100
150	6"	904-002G	51,67	904-002H	38,76	904-160-150 / 904-200-150
200	8"	904-003G	129,82	904-003H	64,92	904-250-200 / 904-350-200 / 904-520-200

L mm	L"	Corps		
		Part N°	€	Apte pour
100	4"	904-90-100C	30,63	904-90-100
100	4"	904-130-100C	32,71	904-130-100
150	6"	904-160-150C	51,67	904-160-150
150	6"	904-200-150C	71,14	904-200-150
200	8"	904-250-200C	90,88	904-250-200
200	8"	904-350-200C	108,02	904-350-200
200	8"	904-520-200C	321,35	904-520-200

Extracteurs

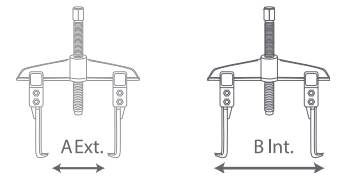

905

Extracteur multiple 2 griffes

CrV

100 mm

200 mm

250 mm



M14x1,50

L mm	A min-A max	B min-B max	Part N°	€
100-250	30-140	55-170	905-001	263,77

Corps	
Part N°	€
905-001C	79,13

Arbre	
Part N°	€
905-001H	52,75

		Griffe	
L mm	L"	Part N°	€/u.
100	4"	905-001G1	44,84
200	8"	905-001G2	55,39
250	10"	905-001G3	73,85

905

Extracteur multiple 3 griffes

CrV

100 mm

200 mm

250 mm



M14x1,50

L mm	A min-A max	B min-B max	Part N°	€
100-250	30-140	70-170	905-002	378,02

Corps	
Part N°	€
905-002C	94,50

Arbre	
Part N°	€
905-001H	52,75

		Griffe	
L mm	L"	Part N°	€/u.
100	4"	905-001G1	44,84
200	8"	905-001G2	55,39
250	10"	905-001G3	73,85

Outils Divers

Extracteurs



905

Extracteur multiple 3 griffes

CrV

200
mm

300
mm



L mm	A min-A max	B min-B max	Part N°	€
200-300	40-220	110-270	905-003	467,66

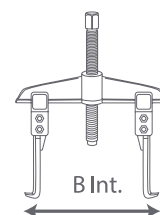
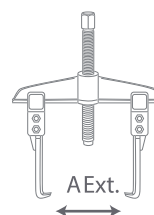

Corps	
Part N°	€
905-003C	126,27

Arbre	
Part N°	€
905-003H	93,53

Griffe			
L mm	L"	Part N°	€/u.
200	8"	905-003G2	98,20
250	10"	905-003G3	107,57

905

Extracteur multiple 2 et 3 griffes

Cr-V

100 mm

200 mm

250 mm

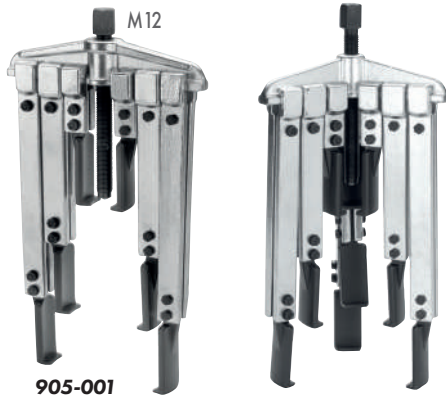

905-001

905-002

L mm	A min-A max	B min-B max	Part N°	€
100-250	30-140	55-170	905-004	455,09

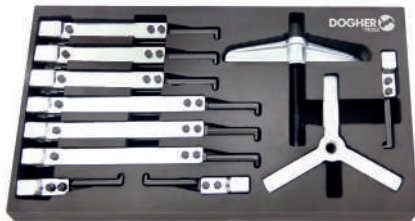
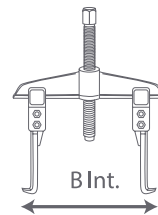
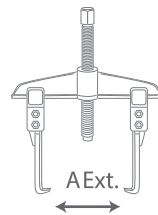

905-001



905-002

Corps	Part N°	€
	905-001C	79,13
	905-002C	94,50

Arbre	Part N°	€
	905-001H	52,75

		Griffe	
L mm	L"	Part N°	€/u.
100	4"	905-001G1	44,84
200	8"	905-001G2	55,39
250	10"	905-001G3	73,85

Outils Divers

Décolleurs



905

Coffret de décolleurs de roulements

CrV

30-50
mm

50-75
mm

min-max	Part N°	€
30-75	905-005	264,13



905

Décolleur de roulements

CrV

30-50
mm



min-max	Part N°	€
30-50	905-006	53,80

905

Décolleur



Compatible avec 905-006

Part N°	€
905-600	55,24

905

Décolleur de roulements

CrV

50-75
mm



min-max	Part N°	€
50-75	905-007	72,58

905

Décolleur



Compatible avec 905-007

Part N°	€
905-700	55,24

905

Décolleur de roulements

CrV

75-105
mm



min-max	Part N°	€
75-105	905-008	97,50

905

Décolleur



Compatible avec 905-008

Part N°	€
905-800	117,63

905

Décolleur de roulements

CrV

100-150
mm



min-max	Part N°	€
100-150	905-009	275,50

905

Décolleur



Compatible avec 905-009

Part N°	€
905-900	121,05

Arrache-rotules

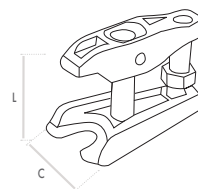

905 Arrache-rotules universel

CrV

12-50
mm

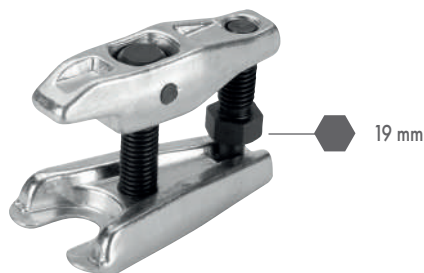

L min-max	C min-max	Part N°	€
12-50	18-22	905-010	30,90

905 Arrache-rotules

CrV

12-50
mm

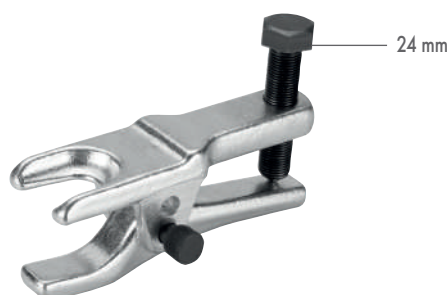

min-max	C	Part N°	€
12-50	20	905-011	60,23

905 Arrache-rotules

CrV

60-80
mm

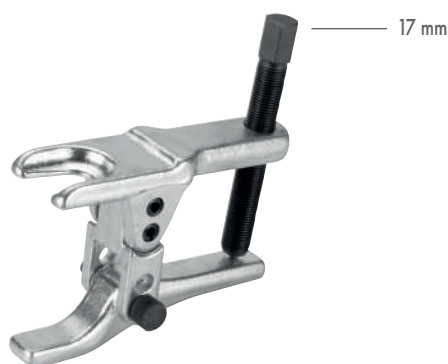

min-max	C	Part N°	€
60-80	20	905-012	78,27

905 Clé à Filtre 3 Griffes Réglable



Ø mm	Part N°	€
65-120	905-020	20,72

Outils Divers

Pistolets à Silicone

- Poignée et Corps en Aluminium
- Force de poussée: 1500N/4000N
- Douille de poussée renforcée: 11 mm
- Avance/Pression: 10mm
- Tige du poussoir: 7,9mm

XTREME

DOGHER
TOOLS

914

Pistolet à Triple Piston

225 mm
Al
1500 NW
9"



L mm	Ø mm	Part N°	€
225	78	914-225	34,46

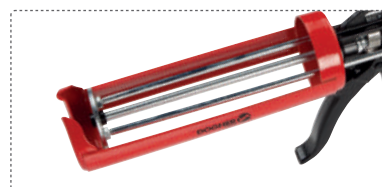

915

Pistolet avec Coupe Intégrée

225 mm
Al
1500 NW
9"
360°



L mm	Ø mm	Part N°	€
225	57	915-225	23,78



916

Pistolet à Silicone à Retour Rapide

225 mm
Al
1500 NW
9"
360°



L mm	Ø mm	Part N°	€
225	55	916-225	21,64

917

Pistolet à Silicone Ultra-Puissant

225 mm
Al
4000 NW
25:1
9"
360°



L mm	Ø mm	Part N°	€
225	55	917-225	37,84

912

Pistolet à Silicone Manche en Aluminium

Ø mm
50



L mm	Ø mm	Part N°	€
225	55	912-225	19,83
250	55	912-250	20,61
360	55	912-325	24,25



910

Pistolet à Silicone Corps en Acier

Ø mm
50



L mm	Ø mm	Part N°	€
225	50	910-225	6,02
250	50	910-250	6,77*

* Jusqu'à fin des stocks

911

Pistolet à Silicone Manche en Zinc

Ø mm
50



L mm	Ø mm	Part N°	€
225	50	911-225	9,06

Outils Divers

Pistolet pour Mousse et Pistolet à Mortier

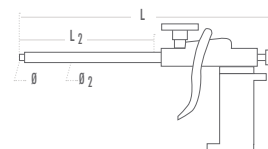

913

Pistolet à Mortier Corps en Aluminium

Ø mm
50



L mm	Ø mm	Part N°	€
225	50	913-225	22,49
300	50	913-300	23,49
375	50	913-375*	26,79

* Capacité: 600cm³ / cartouche
• Levier de poussée renforcé

Accessoires pour Pistolet à Mortier

913

Embouts de Rechange pour Pistolet à Mortier

2
Pcs

Apte pour
913



Part N°	€ / 2Pcs
913-001	1,68

914

Pistolet pour Mousse Polyuréthane Pro

Ø mm
11



L mm	L ₂ mm	Ø mm	Ø ₂ mm	Part N°	€
325	190	11	14	914-001	42,43

• Corps renforcé. Lance et molette de réglage recouvertes intérieur/ extérieur en Teflon afin de garantir une durabilité plus importante.

914

Pistolet pour Mousse Polyuréthane

Ø mm
11



L mm	L ₂ mm	Ø mm	Ø ₂ mm	Part N°	€
325	180	11	12	914-002	31,99

915

Pompe À Graisse avec Tuyau Rigide

**10.000
PSI**



- Valve de libération d'air
- Charge Vrac

1/8 BSP



Vrac cc	Cartouche gr	L pompe	Ø pompe	L flexible	Ø flexible	Part N°	€
500	400	380	57,5	190	9,5	915-010	59,12

915

Pompe À Graisse avec Tuyau Flexible

**3.000
PSI**

1/8 BSP



915-020

**8.000
PSI**

1/8 BSP



915-030



- Valve de libération d'air
- Charge Vrac

Vrac cc	Cartouche gr	L pompe	Ø pompe	L flexible	Ø flexible	Part N°	€
-	-	330	51,5	300	8,5	915-020	35,70
500	400	350	57,5	300	8,5	915-030	38,91

915

Flexible pour Pompe à Graisse



L mm	Part N°	€
300	915-021	7,88

915

Tuyau Rigide pour Pompe à Graisse



L mm	Part N°	€
190	915-022	7,88

Outils Divers

Riveteuses



918

Riveteuse Professionnelle

- Tête à embouts interchangeables
- Inclut 4 embouts \varnothing 2,4-3,2-4-4,8 mm
- Ressort intégré qui éjecte la tige du rivet
- Poignée confortable et anti-glisse



Part N°	€
918-010	31,16

918

Embouts de Rechange

- 4 Embouts de rechange pour riveteuse Réf. 918-010
- Inclut 1x \varnothing 2,4-3,2-4-4,8mm



Part N°	€
918-1	4,10

918

Riveteuse Automatique

4 en 1

- Tête Multi-Embouts
- 4 \varnothing de rivets 2,4-3,2-4-4,8 mm
- Ressort intégré qui éjecte la tige du rivet
- Poignée confortable et anti-glisse



Part N°	€
918-012	33,76

919

Riveteuse à Deux Mains à Tête Multi-Dimensions

- Mors en carbure
- Multiplicateur de force interne
- Poignées ergonomiques
- Corps en aluminium
- Pour rivets \varnothing 2,4-3,2-4-4,8-6,4 mm
- Rivets en acier inoxydable : \varnothing 2,4-3,2-4-4,8 mm

XTREME



L mm	L"	Part N°	€
320	13	919-016	71,99

919

Embouts et Mors de Rechange

Mors		Embouts		
Part N°	€	L mm	Part N°	€
919-016M	13,11	2,4	919-016-024	11,90
		3,2	919-016-032	11,90
		4,0	919-016-040	11,90
		4,8	919-016-048	11,90
		6,4	919-016-064	11,90



919

Riveteuse Manuelle Multi-fonctions



XTREME



3 en 1

Part N°	€
919-020	148,76

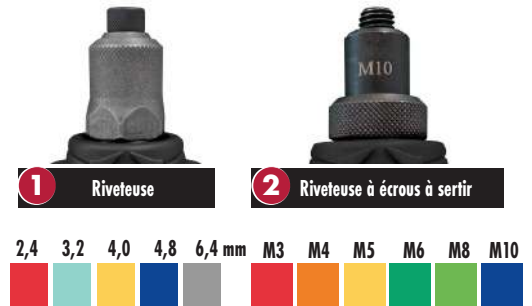

919

Pièces de Rechange pour Riveteuse Multi-Fonctions

Mors		Agrandisseur		Embout			Embout		
Part N°	€	Part N°	€	L mm	Part N°	€	M	Part N°	€
919-020M	13,23	919-020-EA	21,67	2,4	919-020-024	12,86	M3	919-020-M3	20,72
		919-020-EB	21,67	3,2	919-020-032	12,86	M4	919-020-M4	20,72
				4,0	919-020-040	12,86	M5	919-020-M5	20,72
				4,8	919-020-048	12,86	M6	919-020-M6	20,72
				6,4	919-020-064	12,86	M8	919-020-M8	20,72
							M10	919-020-M10	20,72

919

Riveteuse à Erous à Sertir à Une Main à Tête Multi-Dimensions

- Tête à embouts interchangeables
- Inclut 4 embouts M3-M4-M5-M6.



L mm	L"	Part N°	€
210	8	919-022	97,64

Outils Divers

Riveteuses



919

Riveteuse à Écrous à Sertir

410
mm

16"

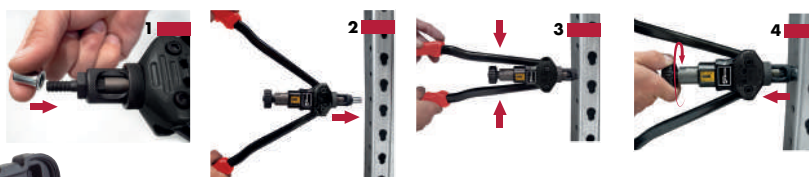

L mm	L"	Part N°	€
410	16	919-025	125,25

- Spécifique pour travail intensif.
- Riveteuse ergonomique pour une réduction des efforts.
- Remplacement facile des composants.
- Inclut clé multi-fonctions.
- Inclut 7 embouts M3-M4-M5-M6-M8-M10-M12.



919

Embouts

M	Part N°	€
M3	919-025-M3	18,46
M4	919-025-M4	18,46
M5	919-025-M5	18,46
M6	919-025-M6	18,46
M8	919-025-M8	18,46
M10	919-025-M10	18,46
M12	919-025-M12	18,46

919

Riveteuse à Écrous à Sertir

- Tête à embouts interchangeable
- Inclut 7 embouts M3-M4-M5-M6-M8-M10-M12.



L mm	L"	Part N°	€
350	14	919-026	155,42



919

Embouts

M	Part N°	€
M3	919-025-M3	18,46
M4	919-025-M4	18,46
M5	919-025-M5	18,46
M6	919-025-M6	18,46
M8	919-025-M8	18,46
M10	919-025-M10	18,46
M12	919-025-M12	18,46

945 Ventouse



Ø mm	Capacité	Part N°	€
115	50 kg	945-001	19,41

- Corps en aluminium avec 1 tête.
- Utilisation à une main.
- Idéal pour le travail dans l'automobile ou le transport de produits.
- Utiliser sur des surfaces lisses et non poreuses.

945 Ventouse



Ø mm	Capacité	Part N°	€
115	100 kg	945-002	38,83

- Corps en aluminium avec 2 têtes.
- Idéal pour le travail dans l'automobile ou le transport de produits.
- Utiliser sur des surfaces lisses et non poreuses

945 Ventouse Double Articulée Spéciale pour Surfaces Courbes



Ø mm	Capacité	Part N°	€
118	80 kg	945-005	46,60

- Corps avec 2 têtes.
- Manche articulé, permettant de fléchir pour s'adapter aux surfaces courbes.
- Spécialement conçu pour l'entretien des véhicules, la pose et dépose de la tôle et du verre

945 Ventouse



Ø mm	Capacité	Part N°	€
115	130 kg	945-003	53,70

- Corps en aluminium avec 3 têtes.
- Idéal pour le travail dans l'automobile ou le transport de produits lourds.
- Utiliser sur des surfaces lisses et non poreuses.

945 Ventouse



Ø mm	Capacité	Part N°	€
203	180 kg	945-004	102,25

- Ventouse robuste avec pompe à main et disque en caoutchouc de 203 mm
- Indicateur rouge de sécurité : avertissement de perte d'aspiration
- Soupape de décompression manuelle.
- Pour une utilisation sur des surfaces structurées et courbes

Outils Divers

Ventouses, Miroir et Perforateurs



945

Ventouse avec Pompe À Vide Spéciale pour les Pare-Brises



Ø mm	Capacité	Part N°	€
230	200 kg	945-006	176,94

- Corps en plastique avec 1 tête.
- Spécifique pour les surfaces courbes, notamment les pare-brises.



930

Miroir d'Inspection Télescopique

Inox

- Miroir de qualité industrielle permettant une visualisation parfaite dans des zones d'accès difficile
- Miroir télescopique. Replié: 240 mm. Déplié: jusque 930 mm
- Double articulation permettant de positionner le miroir dans tous les angles
- Manche anti-glisse

360°



L min-max	Part N°	€
240-930	930-001	14,54



940

Perforateur Professionnel



- Trous propres et précis dans les matières tendres comme le cuir, les plastiques fins, le papier, le tissu...
- ø 2-2,5-3-3,5-4-4,5 mm
- Manche plastifié ergonomique



Part N°	€
940-001	21,38

940

Perforateur à Frappe



- Manche moleté anti-glisse
- ø 2-2,5-3-3,5-4-4,5 mm



Part N°	€
940-002	19,44

925

Étau D'établi Guide Rond

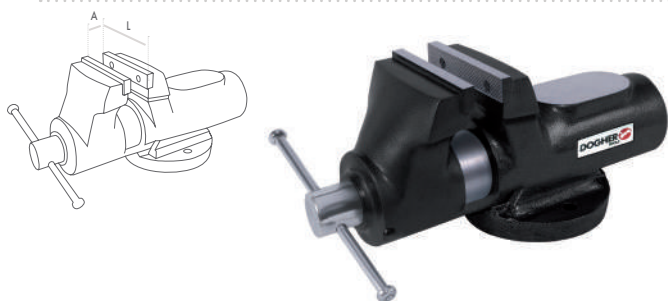

L mm	A mm	Kg	Part N°	€
100	105	13	925-100	307,46
125	130	22	925-125	423,33
150	165	32	925-150	604,48

926

Étau D'établi Guide Carré

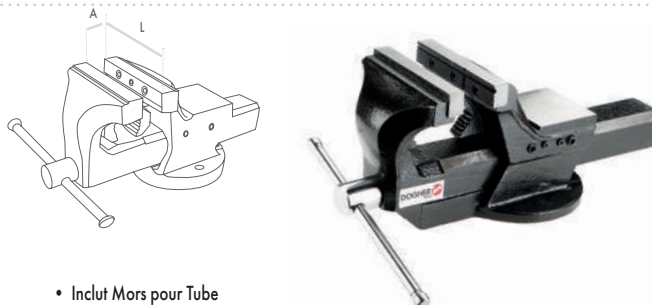

• Inclut Mors pour Tube

L mm	A mm	Kg	Part N°	€
100	105	7,5	926-100	187,72
125	155	14	926-125	209,19
150	165	19	926-150	302,02
175	205	26	926-175	478,31

925R

Mors de Rechange

Apte pour
925

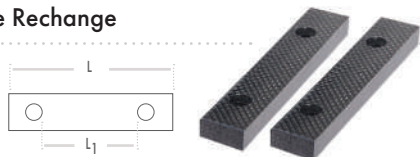

L mm	L ₁ mm	Part N°	€ / 2Pcs
100	53	925R-100	25,11
125	73	925R-125	37,20
150	88	925R-150	45,51

926R

Mors de Rechange

Apte pour
926

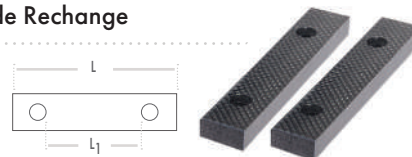

L mm	L ₁ mm	Part N°	€ / 2Pcs
100	24	926R-100	30,26
125	28	926R-125	35,71
150	43	926R-150	40,77
175	53	926R-175	45,65

925B

Base Tournante

Apte pour
925



L mm	Part N°	€
100	925B-100	34,63
125	925B-125	38,91
150	925B-150	56,03

926B

Base Tournante

Apte pour
926



L mm	Part N°	€
100	926B-100	29,89
125	926B-125	32,04
150	926B-150	41,15
175	926B-175	64,95

Outils Divers

Mini-Étaux et Clé à Filtré



927

Mini Étau d'Établi

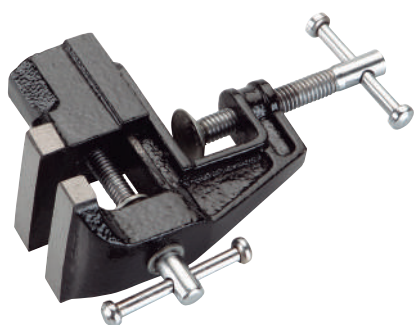

L mm	Part N°	€
50	927-050	19,26



927

Mini Étau d'Établi



L mm	Part N°	€
90	927-060	34,51

• Ouverture maximale: 40mm

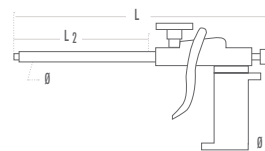

914

Soufflette Progressive

Ø mm
8



L mm	L ₂ mm	Ø mm	Ø ₂ mm	Part N°	€
210	100	8	1/4" G (BSP)	914-010	17,51

- Pression maximum: 12 Bar · 175 PSI · 1,2 Mpa
- Buse à renfort métallique.
- Corps en POM (Acétal) de haut rendement.

914

Soufflette Progressive

Ø mm
8



L mm	L ₂ mm	Ø mm	Ø ₂ mm	Part N°	€
306	202	8	1/4" G (BSP)	914-015	20,52

- Pression maximum: 12 Bar · 175 PSI · 1,2 Mpa
- Buse à renfort métallique.
- Corps en POM (Acétal) de haut rendement.

914

Soufflette Progressive

Ø mm
8



L mm	L ₂ mm	Ø mm	Ø ₂ mm	Part N°	€
212	93	8	1/4" G (BSP)	914-020	22,17

- Niveau de bruit faible
- Pression maximum: 12 Bar · 175 PSI · 1,2 Mpa
- Buse à renfort métallique.
- Corps en POM (Acétal) de haut rendement.
- Fabriquée selon la norme OSHA (Administration de la sécurité et de la santé au travail).



Outils Divers

Emporte-Pièces



Emporte-pièces à têtes interchangeables :

Les nouveaux emporte-pièces **XTREME** permettent à l'opérateur de percer des trous de précision pour obtenir des joints, des rondelles, etc.

Le changement rapide des têtes et des mandrins est possible grâce au système fileté et au système **FASTClick**.

- Les têtes de 2 à 10 mm de diamètre sont reliées à l'emporte-pièces au moyen d'un filetage interne M13x1.
- Les têtes de 11 à 60 mm de diamètre sont reliées à l'emporte-pièces au moyen du système **FASTClick**.
- Les arbres 940-250M et 940-260M sont reliés à l'emporte-pièces 940-02-60 au moyen d'un filetage M20x1,5.

Ils sont recommandés pour une utilisation sur des plaques d'aluminium, acier, cuir, caoutchouc, carton, mousse, plastique, fibre...

CAPACITÉ DE COUPE

Plaques acier-cuivre-aluminium : 0,3 mm d'épaisseur.



940

Emporte-Pièces en Acier



L mm	Ø mm	Part N°	€
120	16	940-02-10	33,39

- Pour Têtes de Ø 2 - 10 mm

940

Emporte-Pièces en Acier



L mm	Ø mm	Part N°	€
95	24	940-03-20	45,50

- Pour Têtes de Ø 2 - 20 mm

940

Emporte-Pièces Manche Bi-Matière



L mm	Ø mm	Part N°	€
180	34,5	940-02-60	116,57

- Pour Têtes de Ø 2 - 60 mm

940

Emporte-Pièces Manche Bi-Matière



L mm	Ø mm	Part N°	€
180	35	940-03-30	126,93

- Pour Têtes de Ø 2 - 30 mm

940

Têtes de Rechange pour Emporte-Pièces

► Têtes Ø 2 - 10 mm
Filetage M13x1

Ø mm	L mm	Part N°	€
2	27	940-102	13,04
3	27	940-103	13,04
4	27	940-104	13,04
5	27	940-105	13,04
6	27	940-106	13,04
7	27	940-107	13,04
8	27	940-108	13,04
9	27	940-109	13,04
10	27	940-110	13,04

► Têtes Ø 11 - 60 mm



Ø mm	L mm	Part N°	€
11	27	940-111	15,62
12	27	940-112	15,62
13	27	940-113	15,62
14	27	940-114	15,62
15	27	940-115	15,62
16	27	940-116	15,62
17	27	940-117	15,62
18	27	940-118	15,62
19	27	940-119	15,62
20	27	940-120	15,62
21	32	940-121	20,67
22	32	940-122	20,67
23	32	940-123	20,67
24	32	940-124	20,67
25	32	940-125	20,67
26	32	940-126	20,67
27	32	940-127	20,67
28	32	940-128	20,67
29	32	940-129	20,67
30	32	940-130	20,67
32	37	940-132	27,21
33	37	940-133	27,21
34	37	940-134	27,21
35	37	940-135	27,21
36	37	940-136	27,21
37	37	940-137	27,21
38	37	940-138	27,21
39	37	940-139	27,21
40	37	940-140	27,21
42	42	940-142	32,38
43	42	940-143	32,38
44	42	940-144	32,38
45	42	940-145	32,38
46	42	940-146	32,38
47	42	940-147	32,38
48	42	940-148	32,38
49	42	940-149	32,38
50	42	940-150	32,38
52	47	940-152	78,76
54	47	940-154	78,76
56	47	940-156	78,76
58	47	940-158	78,76
60	47	940-160	78,76



Outils Divers

Emporte-Pièces



940

Pointe de Centrage



L mm	Ø mm	Part N°	€
54	14	940-210	33,39

940

Barre pour Compas

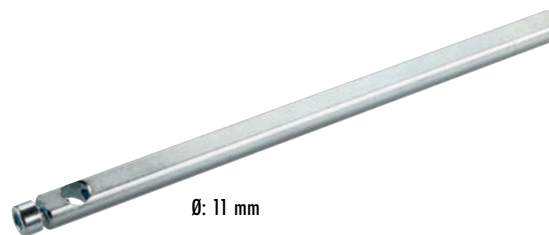

L mm	Ø mm	Part N°	€
420	11	940-211	25,36

940

Lame pour Compas



L mm	Ø mm	Part N°	€
124	16	940-212	35,45

- Comprend une lame 940-213

940

Lame Coupante



Part N°	€
940-213	21,96

940

Arbre Pyramidal

Part N°	€
940-250M	80,93

- Utilisé avec l'emporte-pièces 940-02-60
Inclus dans le jeu 940-250



Part N°	€
940-260M	116,84

- Utilisé avec l'emporte-pièces 940-02-60
Inclus dans le jeu 940-260



940

Emporte-pièces Interchangeables Acier



940-03-20 Ø 2 - 20 mm



940-103 Ø 3
940-104 Ø 4
940-106 Ø 6
940-108 Ø 8
940-110 Ø 10



**Fast
Click**

940-112 Ø 12
940-114 Ø 14
940-116 Ø 16
940-118 Ø 18
940-120 Ø 20

Part N°	€
940-320	138,63



**11
Pcs**



940

Emporte-pièces Interchangeables Bi-matière



940-03-30 Ø 2 - 30 mm



940-103 Ø 3
940-104 Ø 4
940-106 Ø 6
940-108 Ø 8
940-110 Ø 10



**Fast
Click**

940-112 Ø 12
940-114 Ø 14
940-116 Ø 16
940-118 Ø 18
940-120 Ø 20
940-122 Ø 22
940-124 Ø 24
940-126 Ø 26
940-128 Ø 28
940-130 Ø 30

Part N°	€
940-330	277,88



**16
Pcs**



Outils Divers

Emporte-Pièces



940

Emporte-Pièces Interchangeables Bi-matière + Arbre Pyramidal + Pointe de Centrage



940-02-60 Ø 2 - 60 mm



940-102 Ø 2
940-103 Ø 3
940-104 Ø 4
940-105 Ø 5
940-106 Ø 6
940-107 Ø 7
940-108 Ø 8
940-109 Ø 9
940-110 Ø 10

Fast Click



940-112 Ø 12
940-114 Ø 14
940-116 Ø 16
940-118 Ø 18
940-120 Ø 20
940-122 Ø 22
940-124 Ø 24
940-126 Ø 26
940-128 Ø 28
940-130 Ø 30
940-132 Ø 32
940-134 Ø 34
940-136 Ø 36
940-138 Ø 38
940-140 Ø 40
940-142 Ø 42
940-144 Ø 44
940-146 Ø 46
940-148 Ø 48
940-150 Ø 50

940-210



940-250M Ø 2 - 50 mm

32
Pcs



Part N°	€
940-250	542,52

940

Emporte-Pièces Interchangeables Bi-matière + Arbre Pyramidal + Pointe de Centrage + Barre pour Compas + Cutter pour compas avec Lame



940-02-60 Ø 2 - 60 mm



940-102 Ø 2
940-103 Ø 3
940-104 Ø 4
940-105 Ø 5
940-106 Ø 6
940-107 Ø 7
940-108 Ø 8
940-109 Ø 9
940-110 Ø 10

Fast Click



940-112 Ø 12
940-114 Ø 14
940-116 Ø 16
940-118 Ø 18
940-120 Ø 20
940-122 Ø 22
940-124 Ø 24
940-126 Ø 26
940-128 Ø 28
940-130 Ø 30
940-132 Ø 32
940-134 Ø 34
940-136 Ø 36
940-138 Ø 38
940-140 Ø 40
940-142 Ø 42
940-144 Ø 44
940-146 Ø 46
940-148 Ø 48
940-150 Ø 50
940-152 Ø 52
940-154 Ø 54
940-156 Ø 56
940-158 Ø 58
940-160 Ø 60

940-210



940-260M Ø 2 - 60 mm



940-213



940-212



940-211

39
Pcs



Part N°	€
940-260	946,07