

# DOGHER

® TOOLS

*Making Solutions*



	188		232
	192		233
	196		235
	203		236
	208		237
	212		238
	213		239
	218		240
	220		243
	223		
	226		
	228		

## Wrenches

# 450

# Adjustable Wrenches

Spanish Type & Extra Wide Adjustable Wrenches



491

Spanish Type Adjustable Wrench

CrV

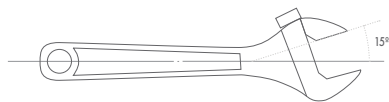

L mm	L "	mm	Part N°	€
150	6	24	491-150	33,27
200	8	29	491-200	37,13
250	10	33	491-250	45,85
300	12	38	491-300	58,04
400	16	50	491-400	96,53
500	20	62	491-500	175,24



230 x 210 x 155 mm

EXP

10 Spanish Type Adjustable Wrenches

10  
Pcs

CrV



491-200 (x4)  
491-250 (x6)

Part N°	€
491-001J	423,62

492

Extra Wide Adjustable Wrench

CrV

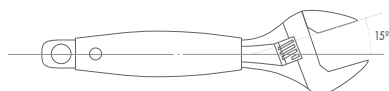

L mm	L "	mm	Part N°	€
150	6	34	492-150	34,47
200	8	38	492-200	37,39
250	10	50	492-250	45,80

# Adjustable Wrenches

## Adjustable Wrenches

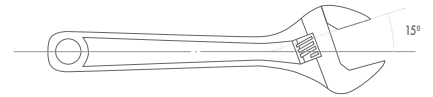

**493**

Professional Adjustable Wrench

CrV



230 x 210 x 155 mm

L mm	L "	mm	Part N°	€
100	4	17	493-100	23,33
150	6	24	493-150	24,02
200	8	29	493-200	27,57
250	10	33	493-250	33,71
300	12	38	493-300	44,19
380	15	50	493-380	75,18
450	18	60	493-450	118,05
600	24	70	493-600	293,29

**EXP**

10 Professional Adjustable Wrenches

**10**  
Pcs

CrV

Part N°	€
493-001J	312,54

493-200 (x4)  
493-250 (x6)



**4930**

Adjustable Wrench

CrV



230 x 210 x 155 mm

L mm	L "	mm	Part N°	€
100	4	13	4930-100	16,37
150	6	19	4930-150	16,53
200	8	24	4930-200	19,09
250	10	28	4930-250	23,97
300	12	34	4930-300	30,95
380	15	43	4930-380	55,60
450	18	52	4930-450	85,48
600	24	62	4930-600	180,85

**EXP**

10 Adjustable Wrenches

**10**  
Pcs

CrV

Part N°	€
4930-001J	220,18

4930-200 (x4)  
4930-250 (x6)



# Adjustable Wrenches

Adjustable Wrenches



496

Ratcheting Adjustable Wrench

CrV

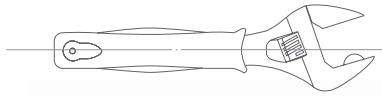

L mm	L "	mm	Part N°	€
150	6	6~20	496-150	31,31
200	8	6~24	496-200	35,96
250	10	6~30	496-250	53,40



160 x 190 x 125 mm

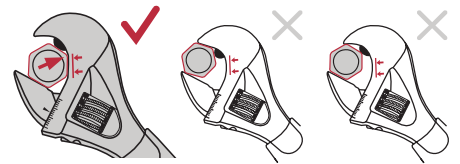

• Put the wrench like in picture

EXP

10 Ratcheting Adjustable Wrenches

10  
Pcs

CrV



496-200 (x10)

Part N°	€
496-001J	359,60

4931

Adjustable Wrench **Alligator**

CrV



L mm	L "	mm	mm	Part N°	€
200	8	32	M3-M10	4931-200	40,98

EXP

10 Adjustable Wrenches

10  
Pcs

CrV



230 x 210 x 155 mm



4931-200 (x10)

Part N°	€
4931-200J	409,80

**491**

EVA Foam Tray

**3**  
Pcs

CrV



1/4 (375 x 140 x 30 mm)



150mm • 200mm • 250mm

Part N°	€
<b>491-080</b>	<b>125,50</b>

**493**

EVA Foam Tray

**3**  
Pcs

CrV



1/4 (375 x 140 x 30 mm)



150mm • 200mm • 250mm

Part N°	€
<b>493-080</b>	<b>94,55</b>

Further Information about Storage and EVA Foam Trays in Pages:

20 • 35

# Wrenches

All the DOGHER TOOLS wrenches are forged in CrV and tempered through a continuous heating. This process gives the tool high hardness and toughness. High resistance against oxidation thanks to the polishing process.

## Double Open Ended Wrenches

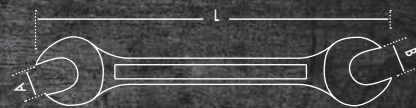

450

### Double Open Ended Wrench

CrV



### SAE

A mm	B mm	L mm	Part N°	€
4	5	110	450-04-05	6,35
4,5	5,5	123	450-04,5-05,5	6,41
5	5,5	123	450-05-05,5	6,53
5,5	7	123	450-05,5-07	6,27
6	7	123	450-06-07	6,12
7	8	129	450-07-08	6,41
8	9	140	450-08-09	6,07
8	10	141	450-08-10	6,63
10	11	155	450-10-11	6,74
10	12	156	450-10-12	7,47
10	13	170	450-10-13	7,98
11	13	172	450-11-13	7,99
12	13	172	450-12-13	7,99
12	14	179	450-12-14	8,70
13	15	189	450-13-15	9,46
13	17	205	450-13-17	10,21
14	15	190	450-14-15	8,63
16	17	204	450-16-17	10,04
16	18	210	450-16-18	10,37
17	19	221	450-17-19	11,48
18	19	220	450-18-19	11,49
19	22	237	450-19-22	13,94
20	22	237	450-20-22	13,72
21	23	247	450-21-23	14,89
22	24	247	450-22-24	14,92
24	26	263	450-24-26	17,30
24	27	266	450-24-27	17,54
25	28	280	450-25-28	20,15
27	29	280	450-27-29	23,74
27	30	285	450-27-30	24,37
27	32	300	450-27-32	26,83
30	32	298	450-30-32	26,87
32	36	350	450-32-36	45,24
34	36	350	450-34-36	47,48
36	41	380	450-36-41	53,04
41	46	415	450-41-46	74,64
46	50	465	450-46-50	97,30

A "	B "	L mm	Part N°	€
1/4"	5/16"	123	450-1/4-5/16	5,85
5/16"	3/8"	140	450-5/16-3/8	6,06
3/8"	7/16"	156	450-3/8-7/16	7,04
7/16"	1/2"	172	450-7/16-1/2	8,42
1/2"	9/16"	172	450-1/2-9/16	8,42
9/16"	5/8"	188	450-9/16-5/8	8,94
5/8"	11/16"	204	450-5/8-11/16	10,41
11/16"	3/4"	220	450-11/16-3/4	11,51
13/16"	7/8"	238	450-13/16-7/8	13,69
15/16"	1"	266	450-15/16-1	17,55
1"	1.1/8"	280	450-1-1.1/8	20,71
1.1/16"	1.1/4"	298	450-1.1/16-1.1/4	26,71



• Hanging unit packaging available

## Double Open Ended Wrench Sets

450

Nylon Pouch

8  
Pcs

Cr-V



390 x 300 mm



- 6x7
- 8x9
- 10x11
- 12x13
- 14x15
- 16x17
- 18x19
- 20x22

Part N°	€
450-001	77,05
450-001V *	20,90

\* Empty Nylon Pouch

450

Nylon Pouch

12  
Pcs

Cr-V



620 x 350 mm



- 6x7
- 8x9
- 10x11
- 12x13
- 14x15
- 16x17
- 18x19
- 20x22
- 21x23
- 24x27
- 25x28
- 30x32

Part N°	€
450-002	157,50
450-002V *	23,92

\* Empty Nylon Pouch

450

Nylon Pouch

7  
Pcs

SAE

Cr-V



300 x 390 mm



- 1/4" x 5/16"
- 5/16" x 3/8"
- 3/8" x 7/16"
- 1/2" x 9/16"
- 9/16" x 5/8"
- 5/8" x 11/16"
- 11/16" x 3/4"

Part N°	€
450-003	64,48
450-003V *	20,90

\* Empty Nylon Pouch

450

Nylon Pouch

11  
Pcs

SAE

Cr-V



620 x 350 mm



- 1/4" x 5/16"
- 5/16" x 3/8"
- 3/8" x 7/16"
- 1/2" x 9/16"
- 9/16" x 5/8"
- 5/8" x 11/16"
- 11/16" x 3/4"
- 13/16" x 7/8"
- 15/16" x 1"
- 1" x 1.1/8"
- 1.1/16" x 1.1/4"

Part N°	€
450-004	144,14
450-004V *	23,92

\* Empty Nylon Pouch

# Wrenches

## Double Open Ended Wrench Sets



450

Plastic Holder

6  
Pcs

CrV



• 6x7 • 8x9 • 10x11 • 12x13 • 14x15 • 16x17

Part N°	€
450-016	53,84
450-011V *	15,30

\* Empty Plastic Holder

8  
Pcs

CrV



• 6x7 • 8x9 • 10x11 • 12x13 • 14x15 • 16x17  
• 18x19 • 20x22

Part N°	€
450-018	79,05
450-013V *	17,83

\* Empty Plastic Holder

450

Plastic Holder

10  
Pcs

CrV



• 6x7 • 8x9 • 10x11 • 12x13 • 14x15 • 16x17  
• 18x19 • 20x22 • 21x23 • 24x27

Part N°	€
450-020	111,48
450-015V *	22,93

\* Empty Plastic Holder

12  
Pcs

CrV



• 6x7 • 8x9 • 10x11 • 12x13 • 14x15 • 16x17  
• 18x19 • 20x22 • 21x23 • 24x27 • 25x28 • 27x29

Part N°	€
450-022	155,37
450-017V *	24,21

\* Empty Plastic Holder

12  
Pcs

CrV



• 6x7 • 8x9 • 10x11 • 12x13 • 14x15 • 16x17  
• 18x19 • 20x22 • 21x23 • 24x26 • 25x28 • 30x32

Part N°	€
450-024	158,26
450-017V *	24,21

\* Empty Plastic Holder



## Double Open Ended Wrench Sets

450

Carton Box

5  
Pcs

Cr-V



• 6x7 • 8x9 • 10x11 • 12x13 • 14x15

Part N°	€
450-035	43,80

450

Carton Box

6  
Pcs

Cr-V



• 6x7 • 8x9 • 10x11 • 12x13 • 14x15 • 16x17

Part N°	€
450-036	53,84

450

Carton Box

8  
Pcs

Cr-V



• 6x7 • 8x9 • 10x11 • 12x13  
• 14x15 • 16x17 • 18x19 • 20x22

Part N°	€
450-038	79,05

450

EVA Foam Tray

8  
Pcs

Cr-V



1/4 (375 x 140 x 30 mm)



• 6x7 • 8x9 • 10x11 • 12x13 • 14x15  
• 16x17 • 18x19 • 20x22

Part N°	€
450-080	80,05

450

EVA Foam Tray

10  
Pcs

Cr-V



1/3 (375 x 188 x 30 mm)



• 6x7 • 8x9 • 10x11 • 12x13 • 14x15  
• 16x17 • 18x19 • 20x22 • 21x23 • 24x26

Part N°	€
450-081	115,49

450

EVA Foam Tray

3  
Pcs

Cr-V



1/3 (375 x 188 x 30 mm)



• 25x28 • 27x29 • 30x32

Part N°	€
450-082	83,26

# Wrenches

## Combination Wrenches

- Maximum load distribution
- Quick tightening
- Maximum performance without wear
- Decreases damage to nuts and bolts
- Longer lifetime of the wrench
- Maximum contact surface
- Homogeneous stress distribution

Effect of stress:

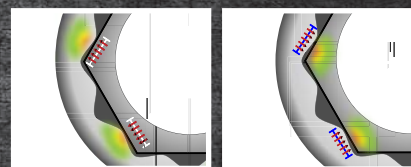

• On the wrench

• On the nut

451

## Combination Wrench

CrV

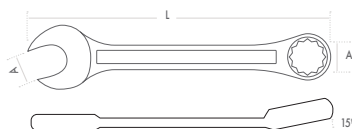

SAE

A"	L mm	Part N°	€
7/32"	100	451-7/32	6,85
1/4"	100	451-1/4	6,87
9/32"	110	451-9/32	6,41
5/16"	120	451-5/16	7,10
11/32"	130	451-11/32	6,41
3/8"	140	451-3/8	8,37
7/16"	150	451-7/16	9,25
1/2"	170	451-1/2	10,40
9/16"	180	451-9/16	10,62
5/8"	200	451-5/8	11,78
11/16"	210	451-11/16	12,69
3/4"	230	451-3/4	15,03
13/16"	250	451-13/16	17,37
7/8"	260	451-7/8	17,72
15/16"	280	451-15/16	19,38
1"	290	451-1	21,15
1.1/16"	310	451-1.1/16	27,76
1.1/8"	330	451-1.1/8	29,48
1.1/4"	360	451-1.1/4	35,15
1.5/16"	380	451-1.5/16	42,55
1.3/8"	410	451-1.3/8	59,80
1.7/16"	410	451-1.7/16	59,90
1.1/2"	410	451-1.1/2	62,85
1.5/8"	460	451-1.5/8	75,94
1.11/16"	460	451-1.11/16	98,27
1.3/4"	500	451-1.3/4	105,25
1.13/16"	500	451-1.13/16	98,07
1.7/8"	540	451-1.7/8	111,97
2"	540	451-2	113,48
2.1/8"	560	451-2.1/8	196,73
2.1/4"	600	451-2.1/4	196,73
2.3/8"	600	451-2.3/8	275,93
2.1/2"	680	451-2.1/2	341,96
2.5/8"	680	451-2.5/8	341,96
2.3/4"	680	451-2.3/4	363,72
2.7/8"	730	451-2.7/8	441,45
3"	730	451-3	441,45

A mm	L mm	Part N°	€
4	80	451-04	9,29
5,5	100	451-05,5	6,62
6	100	451-06	6,67
7	110	451-07	6,70
8	120	451-08	6,85
9	130	451-09	8,15
10	140	451-10	8,22
11	150	451-11	9,26
12	160	451-12	9,58
13	170	451-13	9,99
14	180	451-14	10,55
15	190	451-15	10,87
16	200	451-16	11,39
17	210	451-17	12,18
18	220	451-18	12,85
19	230	451-19	14,66
20	240	451-20	15,16
21	250	451-21	17,14
22	260	451-22	17,22
23	270	451-23	18,56
24	280	451-24	18,90
25	290	451-25	21,00
26	300	451-26	25,07
27	310	451-27	26,66
28	320	451-28	29,25
29	330	451-29	29,71
30	340	451-30	32,35
32	360	451-32	35,16
33	380	451-33	54,38
34	380	451-34	46,27
35	410	451-35	67,68
36	410	451-36	60,60
38	430	451-38	67,90
41	460	451-41	70,75
43	460	451-43	106,42
46	500	451-46	96,39
48	540	451-48	134,31
50	540	451-50	107,67
55	560	451-55	186,89
58	600	451-58	282,90
60	600	451-60	247,54
65	680	451-65	329,96
70	680	451-70	388,27
75	730	451-75	499,70
80	730	451-80	572,61
85	790	451-85	774,87
90	790	451-90	1.002,90
95	790	451-95	1.060,66
100	860	451-100	1.130,92
105	860	451-105	1.167,57

**451**

Nylon Pouch

**14**  
Pcs

Cr-V



470 x 390 mm

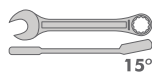

• 9 • 10 • 11 • 12 • 13 • 14 • 15  
• 16 • 17 • 18 • 19 • 20 • 21 • 22

Part N°	€
451-001	174,47
451-001V *	19,72

\* Empty Nylon Pouch

**451**

Nylon Pouch

**14**  
Pcs

Cr-V



650 x 440 mm

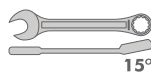

• 8 • 9 • 10 • 11 • 12 • 13 • 14  
• 17 • 19 • 22 • 24 • 27 • 30 • 32

Part N°	€
451-002	228,23
451-002V *	23,02

\* Empty Nylon Pouch

**451**

Nylon Pouch

**17**  
Pcs

Cr-V



470 x 450 mm

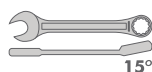

• 6 • 7 • 8 • 9 • 10 • 11 • 12 • 13 • 14  
• 15 • 16 • 17 • 18 • 19 • 20 • 21 • 22

Part N°	€
451-003	197,69
451-003V *	19,72

\* Empty Nylon Pouch

**451**

Nylon Pouch

**18**  
Pcs

Cr-V



650 x 480 mm

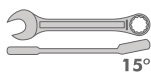

• 8 • 9 • 10 • 11 • 12 • 13 • 14 • 15 • 16  
• 18 • 19 • 22 • 23 • 24 • 26 • 27 • 30 • 32

Part N°	€
451-004	296,54
451-004V *	22,15

\* Empty Nylon Pouch

# Wrenches

## Combination Wrenches Sets



451

Nylon Pouch

24  
Pcs

Cr-V

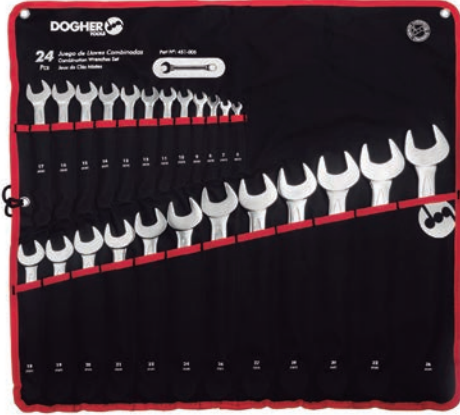

650 x 580 mm

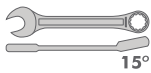

- 6 • 7 • 8 • 9 • 10 • 11 • 12 • 13 • 14
- 15 • 16 • 17 • 18 • 19 • 20 • 21 • 22 • 24
- 26 • 27 • 28 • 30 • 32 • 36

Part N°	€
451-005	425,68
451-005V *	26,81

\* Empty Nylon Pouch

451

Nylon Pouch

26  
Pcs

Cr-V



650 x 500 mm

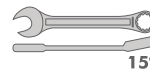

- 6 • 7 • 8 • 9 • 10 • 11 • 12 • 13 • 14
- 15 • 16 • 17 • 18 • 19 • 20 • 21 • 22 • 23
- 24 • 25 • 26 • 27 • 28 • 29 • 30 • 32

Part N°	€
451-006	434,35
451-006V *	26,81

\* Empty Nylon Pouch

451

Nylon Pouch

8  
Pcs

SAE

Cr-V



330 x 300 mm

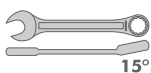

- 1/4" • 5/16" • 3/8" • 7/16" • 1/2" • 9/16"
- 5/8" • 11/16"

Part N°	€
451-007	83,33
451-007V *	17,99

\* Empty Nylon Pouch

451

Nylon Pouch

12  
Pcs

SAE

Cr-V



550 x 350 mm

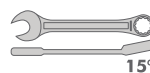

- 3/8" • 7/16" • 1/2" • 9/16" • 5/8" • 11/16"
- 3/4" • 13/16" • 7/8" • 15/16" • 1" • 1.1/16"

Part N°	€
451-008	188,77
451-008V *	22,50

\* Empty Nylon Pouch

**451** Nylon Pouch

**14**  
Pcs

**SAE**

Cr-V



650 x 440 mm

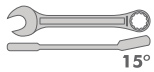

- 3/8"
- 7/16"
- 1/2"
- 9/16"
- 5/8"
- 11/16"
- 3/4"
- 13/16"
- 7/8"
- 15/16"
- 1"
- 1.1/16"
- 1.1/8"
- 1.1/4"

Part N°	€
451-009	254,40
451-009V *	23,02

\* Empty Nylon Pouch

**451** Carton Box

**5**  
Pcs

Cr-V

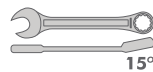

- 8
- 10
- 11
- 12
- 13

Part N°	€
451-035	52,15

**451** Carton Box

**6**  
Pcs

Cr-V

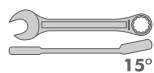

- 8
- 10
- 11
- 12
- 13
- 14

Part N°	€
451-036	62,70

**451** Carton Box

**8**  
Pcs

Cr-V

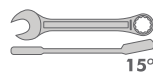

- 8
- 10
- 11
- 12
- 13
- 14
- 17
- 19

Part N°	€
451-038	89,54

# Wrenches

## Combination Wrenches Sets



451

Plastic Holder

5  
Pcs

CrV

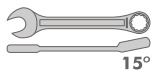

8 • 10 • 13 • 17 • 19

6  
Pcs

CrV

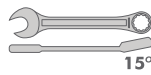

8 • 10 • 11 • 13 • 17 • 19

6  
Pcs

CrV

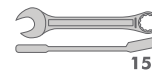

8 • 10 • 11 • 12 • 13 • 14

Part N°	€
451-014	60,15
450-011V *	15,30

\* Empty Plastic Holder

Part N°	€
451-015	69,41
450-011V *	15,30

\* Empty Plastic Holder

Part N°	€
451-016	62,70
450-011V *	15,30

\* Empty Plastic Holder

451

Plastic Holder

8  
Pcs

CrV

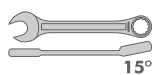

8 • 10 • 11 • 12 • 13 • 14 • 17 • 19

10  
Pcs

CrV

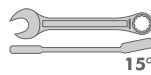

8 • 9 • 10 • 11 • 12  
13 • 14 • 15 • 16 • 17

12  
Pcs

CrV

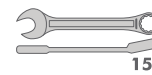

8 • 9 • 10 • 11 • 12 • 13  
14 • 15 • 16 • 17 • 18 • 19

Part N°	€
451-018	89,54
450-013V *	17,83

\* Empty Plastic Holder

Part N°	€
451-020	105,29
450-015V *	22,93

\* Empty Plastic Holder

Part N°	€
451-022	132,80
450-017V *	24,21

\* Empty Plastic Holder

**451**

EVA Foam Tray

**8**  
Pcs

CrV



1/4 (375 x 140 x 30 mm)

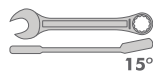

• 8 • 10 • 11 • 12 • 13 • 14 • 17 • 19

Part N°	€
<b>451-080</b>	<b>90,54</b>

**451**

EVA Foam Tray

**11**  
Pcs

CrV



1/3 (375 x 188 x 30 mm)

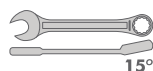

• 7 • 8 • 10 • 11 • 12 • 13 • 14  
• 17 • 19 • 22 • 24

Part N°	€
<b>451-082</b>	<b>136,61</b>

**451**

Combination Wrenches

**10**  
Pcs



1/3 (375 x 188 x 30 mm)

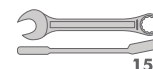

• 8 • 10 • 11 • 12 • 13 • 14 • 17 • 19 • 22 • 24

Part N°	€
<b>451-081</b>	<b>129,91 *</b>

\* Until end of stock

**451**

EVA Foam Tray

**3**  
Pcs

CrV



1/3 (375 x 188 x 30 mm)

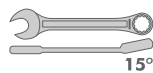

• 27 • 30 • 32

Part N°	€
<b>451-083</b>	<b>106,67</b>

# Wrenches

## Combination Wrenches



### 4551

#### Combination Wrench Long Series



A mm	L mm	Part N°	€
<b>7</b>	136	<b>4551-07</b>	<b>9,80</b>
<b>8</b>	148	<b>4551-08</b>	<b>9,99</b>
<b>9</b>	167	<b>4551-09</b>	<b>9,99</b>
<b>10</b>	172	<b>4551-10</b>	<b>11,03</b>
<b>11</b>	186	<b>4551-11</b>	<b>11,03</b>
<b>12</b>	197	<b>4551-12</b>	<b>12,63</b>
<b>13</b>	207	<b>4551-13</b>	<b>12,63</b>
<b>15</b>	233	<b>4551-15</b>	<b>15,25</b>
<b>17</b>	261	<b>4551-17</b>	<b>17,24</b>
<b>19</b>	280	<b>4551-19</b>	<b>21,84</b>
<b>21</b>	301	<b>4551-21</b>	<b>21,84</b>
<b>24</b>	338	<b>4551-24</b>	<b>27,94</b>
<b>27</b>	375	<b>4551-27</b>	<b>36,25</b>
<b>32</b>	435	<b>4551-32</b>	<b>43,87</b>

### 4561

#### Twisted Combination Wrench



A mm	L mm	Part N°	€
<b>6</b>	110	<b>4561-06</b>	<b>10,85</b>
<b>7</b>	120	<b>4561-07</b>	<b>10,85</b>
<b>8</b>	130	<b>4561-08</b>	<b>11,08</b>
<b>9</b>	140	<b>4561-09</b>	<b>11,08</b>
<b>10</b>	150	<b>4561-10</b>	<b>12,22</b>
<b>11</b>	160	<b>4561-11</b>	<b>12,22</b>
<b>12</b>	170	<b>4561-12</b>	<b>13,99</b>
<b>13</b>	180	<b>4561-13</b>	<b>13,99</b>
<b>14</b>	190	<b>4561-14</b>	<b>16,88</b>
<b>15</b>	200	<b>4561-15</b>	<b>16,88</b>
<b>16</b>	210	<b>4561-16</b>	<b>18,53</b>
<b>17</b>	220	<b>4561-17</b>	<b>19,10</b>
<b>18</b>	230	<b>4561-18</b>	<b>19,22</b>
<b>19</b>	240	<b>4561-19</b>	<b>24,19</b>



**4510**

Offset Combination Wrench



A mm	L mm	Part N°	€
6	110	4510-06	9,71
7	120	4510-07	9,80
8	130	4510-08	9,95
9	140	4510-09	10,42
10	150	4510-10	10,47
11	160	4510-11	11,22
12	170	4510-12	11,87
13	180	4510-13	12,87
14	190	4510-14	12,97
15	200	4510-15	15,36
16	210	4510-16	16,61
17	220	4510-17	17,17
18	230	4510-18	19,19
19	240	4510-19	20,12
20	250	4510-20	21,33
21	260	4510-21	22,16
22	270	4510-22	24,83
23	280	4510-23	26,83
24	290	4510-24	28,02
25	300	4510-25	29,94
26	310	4510-26	30,21
27	320	4510-27	32,21
28	330	4510-28	36,73
29	340	4510-29	39,21
30	350	4510-30	41,16
32	370	4510-32	43,04

**4510**

Plastic Holder

**5**  
Pcs



8 • 10 • 13 • 17 • 19

Part N°	€
4510-014	78,83
450-011V *	15,30

\* Empty Plastic Holder

**4510**

Plastic Holder

**6**  
Pcs



8 • 10 • 12 • 13 • 14 • 17

Part N°	€
4510-016	83,55
450-011V *	15,30

\* Empty Plastic Holder

**4510**

Plastic Holder

**12**  
Pcs

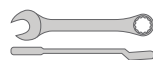

8 • 9 • 10 • 11 • 12 • 13 • 14 • 15 • 16 • 17 • 18 • 19

Part N°	€
4510-022	176,47
450-017V *	24,21

\* Empty Plastic Holder

# Wrenches

## Double Ring Flat Wrenches



454

### Double Ring Flat Wrench

CrV

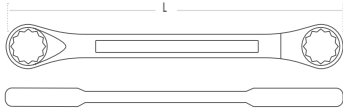

mm	mm	L mm	Part N°	€
6	7	120	454-06-07	10,12
8	9	135	454-08-09	10,48
10	11	150	454-10-11	11,63
12	13	165	454-12-13	12,69
13	17	210	454-13-17	13,50
14	15	185	454-14-15	13,94
16	17	210	454-16-17	14,97
17	19	225	454-17-19	15,55
18	19	225	454-18-19	15,55
20	22	240	454-20-22	18,00
21	23	255	454-21-23	20,67
24	26	270	454-24-26	24,44
24	27	270	454-24-27	24,44
25	28	285	454-25-28	26,07
27	29	315	454-27-29	31,45
30	32	335	454-30-32	33,08

454

### EVA Foam Tray

8  
Pcs

CrV



1/4 (375 x 140 x 30 mm)



Part N°	€
454-080	116,63

Further Information about Storage and EVA Foam Trays in Pages:

20 • 35

**454**

Plastic Holder

**6**  
Pcs

Cr-V



 • 6x7 • 8x9 • 10x11 • 12x13 • 14x15 • 16x17

Part N°	€
454-016	82,08
450-011V *	15,30

\* Empty Plastic Holder

**454**

Plastic Holder

**8**  
Pcs

Cr-V



 • 6x7 • 8x9 • 10x11 • 12x13 • 14x15 • 16x17 • 18x19 • 20x22

Part N°	€
454-018	115,63
450-013V *	17,83

\* Empty Plastic Holder



**454**

Plastic Holder

**10**  
Pcs

Cr-V



 • 6x7 • 8x9 • 10x11 • 12x13 • 14x15 • 16x17 • 18x19  
 • 20x22 • 21x23 • 24x27

Part N°	€
454-020	160,74
450-015V *	22,93

\* Empty Plastic Holder



**454**

Plastic Holder

**12**  
Pcs

Cr-V



 • 6x7 • 8x9 • 10x11 • 12x13 • 14x15 • 16x17 • 18x19  
 • 20x22 • 21x23 • 24x27 • 25x28 • 27x29

Part N°	€
454-022	218,26
450-017V *	24,21

\* Empty Plastic Holder

# Wrenches

## Double Ring Flat Wrenches Sets



454

Nylon Pouch

8  
Pcs

Cr-V



390 x 380 mm



- 6x7
- 8x9
- 10x11
- 12x13
- 14x15
- 16x17
- 18x19
- 20x22

Part N°	€
454-001	113,63
454-001V *	19,97

\* Empty Nylon Pouch

454

Nylon Pouch

10  
Pcs

Cr-V



620 x 480 mm



- 6x7
- 8x9
- 10x11
- 12x13
- 14x15
- 16x17
- 18x19
- 20x22
- 21x23
- 24x26

Part N°	€
454-002	158,74
454-002V *	22,24

\* Empty Nylon Pouch

454

Nylon Pouch

12  
Pcs

Cr-V



620 x 480 mm



- 6x7
- 8x9
- 10x11
- 12x13
- 14x15
- 16x17
- 18x19
- 20x22
- 21x23
- 24x26
- 25x28
- 30x32

Part N°	€
454-003	219,89
454-003V *	23,15

\* Empty Nylon Pouch

**4554**

Double Ring Flat Wrench Long Serie

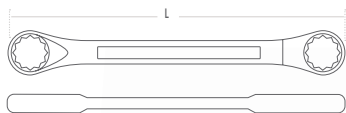



A mm	L mm	Part N°	€
<b>8 x 10</b>	235	<b>4554-08-10</b>	<b>32,82</b>
<b>10 x 12</b>	290	<b>4554-10-12</b>	<b>36,37</b>
<b>12 x 14</b>	328	<b>4554-12-14</b>	<b>39,93</b>
<b>13 x 15</b>	328	<b>4554-13-15</b>	<b>46,06</b>
<b>13 x 17</b>	390	<b>4554-13-17</b>	<b>47,11</b>
<b>16 x 18</b>	404	<b>4554-16-18</b>	<b>49,00</b>
<b>17 x 19</b>	404	<b>4554-17-19</b>	<b>50,81</b>
<b>22 x 24</b>	435	<b>4554-22-24</b>	<b>65,63</b>

**477**

Double E Socket Wrench

CrV



		L mm	Part N°	€
<b>E6</b>	<b>E8</b>	130	<b>477-E6-E8</b>	<b>12,51</b>
<b>E10</b>	<b>E12</b>	144	<b>477-E10-E12</b>	<b>13,79</b>
<b>E14</b>	<b>E18</b>	180	<b>477-E14-E18</b>	<b>16,23</b>
<b>E20</b>	<b>E24</b>	220	<b>477-E20-E24</b>	<b>19,02</b>

# Wrenches

## Double Ring Offset Wrenches



453

### Double Ring Offset Wrench

CrV

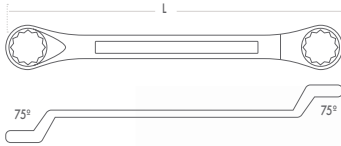

### SAE

mm	mm	L mm	Part N°	€
6	7	170	453-06-07	11,55
8	9	183	453-08-09	12,63
8	10	183	453-08-10	13,35
10	11	197	453-10-11	13,43
10	12	198	453-10-12	14,75
12	13	212	453-12-13	14,77
12	14	214	453-12-14	16,65
13	15	222	453-13-15	19,11
13	17	242	453-13-17	18,74
14	15	230	453-14-15	15,53
16	17	245	453-16-17	18,51
17	19	270	453-17-19	21,44
18	19	275	453-18-19	21,49
19	22	315	453-19-22	25,17
20	22	318	453-20-22	25,41
21	23	327	453-21-23	27,86
22	24	327	453-22-24	29,62
24	26	340	453-24-26	34,50
24	27	340	453-24-27	34,80
25	28	347	453-25-28	40,17
27	29	351	453-27-29	42,18
27	30	351	453-27-30	44,56
30	32	365	453-30-32	48,97
32	36	415	453-32-36	73,67
36	41	450	453-36-41	87,34
41	46	506	453-41-46	115,68
46	50	526	453-46-50	142,67

		L mm	Part N°	€
1/4"	5/16"	170	453-1/4-5/16	11,83
5/16"	3/8"	183	453-5/16-3/8	12,26
3/8"	7/16"	197	453-3/8-7/16	13,19
7/16"	1/2"	212	453-7/16-1/2	14,24
1/2"	9/16"	222	453-1/2-9/16	14,35
9/16"	5/8"	245	453-9/16-5/8	15,75
5/8"	11/16"	246	453-5/8-11/16	17,89
11/16"	3/4"	275	453-11/16-3/4	23,56
13/16"	7/8"	318	453-13/16-7/8	23,96
7/8"	15/16"	327	453-7/8-15/16	31,55
15/16"	1"	340	453-15/16-1	33,22
1"	1.1/8"	347	453-1-1.1/8	39,05
1.1/16"	1.1/4	365	453-1.1/16-1.1/4	42,48
1.1/8"	1.1/4	370	453-1.1/8-1.1/4	50,79

**453**

Nylon Pouch

**6**  
Pcs

Cr-V



350 x 330 mm

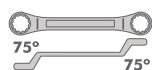

• 6x7 • 8x9 • 10x11 • 12x13 • 14x15 • 16x17

Part N°	€
453-001	92,67
453-001V *	20,32

\* Empty Nylon Pouch

**453**

Nylon Pouch

**8**  
Pcs

Cr-V



390 x 380 mm

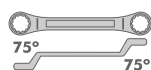

• 6x7 • 8x9 • 10x11 • 12x13 • 14x15  
• 16x17 • 18x19 • 20x22

Part N°	€
453-002	139,57
453-002V *	21,66

\* Empty Nylon Pouch

**453**

Nylon Pouch

**12**  
Pcs

Cr-V



620 x 480 mm

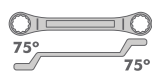

• 6x7 • 8x9 • 10x11 • 12x13 • 14x15 • 16x17  
• 18x19 • 20x22 • 21x23 • 24x27 • 25x28 • 30x32

Part N°	€
453-003	291,37
453-003V *	25,12

\* Empty Nylon Pouch

**453**

Nylon Pouch

**14**  
Pcs

Cr-V



620 x 600 mm

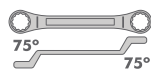

• 6x7 • 8x9 • 10x11 • 12x13 • 14x15  
• 16x17 • 18x19 • 20x22 • 21x23 • 24x26  
• 25x28 • 30x32 • 32x36 • 36x41

Part N°	€
453-004	455,83
453-004V *	26,46

\* Empty Nylon Pouch

# Wrenches

## Double Ring Offset Wrenches Sets



453

Nylon Pouch

7  
Pcs

SAE

Cr-V



390 x 380 mm

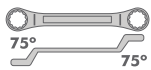

- 1/4" x 5/16"
- 5/16" x 3/8"
- 3/8" x 7/16"
- 7/16" x 1/2"
- 1/2" x 9/16"
- 5/8" x 11/16"
- 11/16" x 3/4"

Part N°	€
453-005	113,57
453-005V *	21,47

\* Empty Nylon Pouch

453

Nylon Pouch

10  
Pcs

SAE

Cr-V



620 x 480 mm

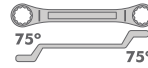

- 1/4" x 5/16"
- 5/16" x 3/8"
- 3/8" x 7/16"
- 7/16" x 1/2"
- 1/2" x 9/16"
- 9/16" x 5/8"
- 5/8" x 11/16"
- 13/16" x 7/8"
- 15/16" x 1"
- 1.1/16" x 1.1/4"

Part N°	€
453-006	205,42
453-006V *	24,79

\* Empty Nylon Pouch

453

Carton Box

8  
Pcs

Cr-V

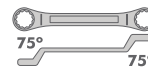

- 6x7
- 8x9
- 10x11
- 12x13
- 14x15
- 16x17
- 18x19
- 20x22

Part N°	€
453-018	141,57



## Double Ring Offset Wrenches Sets

**453**

Plastic Holder

**6**  
Pcs

CrV

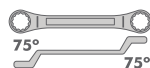

• 8x9 • 10x11 • 12x13 • 14x15 • 16x17 • 18x19

Part N°	€
<b>453-016</b>	<b>104,61</b>
<b>450-011V *</b>	<b>15,30</b>

\* Empty Plastic Holder

**453**

Plastic Holder

**6**  
Pcs

CrV

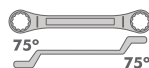

• 6x7 • 8x9 • 10x11 • 12x13 • 14x15 • 16x17

Part N°	€
<b>453-016-2</b>	<b>94,67</b>
<b>450-011V *</b>	<b>15,30</b>

\* Empty Plastic Holder

**453**

EVA Foam Tray

**6**  
Pcs

CrV



1/3 (375 x 188 x 30 mm)

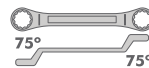

• 8x9 • 10x11 • 12x13 • 14x15 • 16x17 • 18x19

Part N°	€
<b>453-080</b>	<b>108,86</b>

Further Information about Storage and EVA Foam Trays in Pages:

20 • 35

## Half Moon Wrenches

**473**

Half Moon Wrench

CrV



mm	mm	L mm	Part N°	€
<b>11</b>	<b>13</b>	149	<b>473-11-13</b>	<b>12,63</b>
<b>14</b>	<b>17</b>	170	<b>473-14-17</b>	<b>14,24</b>
<b>15</b>	<b>16</b>	170	<b>473-15-16</b>	<b>14,28</b>
<b>15</b>	<b>17</b>	170	<b>473-15-17</b>	<b>14,28</b>
<b>19</b>	<b>22</b>	227	<b>473-19-22</b>	<b>18,27</b>

# Wrenches

## Flare Nut Wrench



**483**

### Flare Nut Wrench

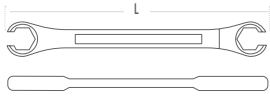

mm	L mm	Part N°	€
8 x 10	131	483-08-10	14,12
9 x 11	151	483-09-11	14,23
10 x 11	152	483-10-11	14,81
10 x 12	152	483-10-12	15,36
12 x 13	168	483-12-13	15,81
12 x 14	177	483-12-14	16,59
14 x 15	177	483-14-15	16,59
14 x 17	194	483-14-17	16,59
17 x 19	214	483-17-19	22,66
19 x 22	235	483-19-22	22,66
22 x 24	255	483-22-24	25,96
24 x 27	273	483-24-27	32,81
30 x 32	292	483-30-32	40,61

**485**

### Flare Nut Gear Wrench



mm	L mm	A mm	B mm	Part N°	€
10	156	32	7	485-10	28,72
11	156	32	7	485-11	28,72
12	156	32	7	485-12	28,72
13	156	32	7	485-13	28,72
14	156	32	7	485-14	28,72
17	210	35	8	485-17	34,98
19	210	37	8	485-19	34,98
22	220	41	11	485-22	38,51
24	220	41	11	485-24	42,14
27	318	49	13	485-27	59,76
32	320	54	17,8	485-32	65,68

**483**

### Plastic Holder

**6**  
Pcs

CrV



Part N°	€
483-016	114,32
450-011V *	15,30

\* Empty Plastic Holder

**457**

Combination Reversible Gear Wrench

CrV

72° 15°

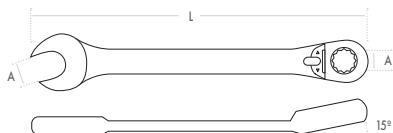

A mm	L mm	Part N°	€
<b>6</b>	120	<b>457-06</b>	<b>26,48</b>
<b>7</b>	120	<b>457-07</b>	<b>26,48</b>
<b>8</b>	134	<b>457-08</b>	<b>26,48</b>
<b>9</b>	158	<b>457-09</b>	<b>27,52</b>
<b>10</b>	158	<b>457-10</b>	<b>29,32</b>
<b>11</b>	164	<b>457-11</b>	<b>30,89</b>
<b>12</b>	167	<b>457-12</b>	<b>31,96</b>
<b>13</b>	177	<b>457-13</b>	<b>34,07</b>
<b>14</b>	189	<b>457-14</b>	<b>35,11</b>
<b>15</b>	198	<b>457-15</b>	<b>36,54</b>
<b>16</b>	204	<b>457-16</b>	<b>37,85</b>
<b>17</b>	224	<b>457-17</b>	<b>39,83</b>
<b>18</b>	245	<b>457-18</b>	<b>41,76</b>
<b>19</b>	245	<b>457-19</b>	<b>42,57</b>
<b>20</b>	280	<b>457-20</b>	<b>50,34</b>
<b>21</b>	280	<b>457-21</b>	<b>44,25</b>
<b>22</b>	280	<b>457-22</b>	<b>47,02</b>
<b>23</b>	320	<b>457-23</b>	<b>60,76</b>
<b>24</b>	310	<b>457-24</b>	<b>51,94</b>
<b>25</b>	320	<b>457-25</b>	<b>70,78</b>
<b>26</b>	320	<b>457-26</b>	<b>76,19</b>
<b>27</b>	330	<b>457-27</b>	<b>60,29</b>
<b>28</b>	355	<b>457-28</b>	<b>97,15</b>
<b>29</b>	355	<b>457-29</b>	<b>98,52</b>
<b>30</b>	425	<b>457-30</b>	<b>80,34</b>
<b>31</b>	425	<b>457-31</b>	<b>111,02</b>
<b>32</b>	425	<b>457-32</b>	<b>86,52</b>
<b>33</b>	425	<b>457-33</b>	<b>116,58</b>
<b>36</b>	445	<b>457-36</b>	<b>201,40</b>

# Gear Wrenches

## Combination Gear Wrench Sets



**457**

Nylon Pouch

**457**

Plastic Holder

**7**

Pcs

CrV



330 x 390 mm

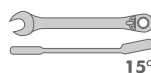

10 • 12 • 13 • 14 • 15 • 17 • 19  
15°

Part N°	€
457-001	255,65
457-001V *	19,09

\* Empty Nylon Pouch

**5**

Pcs

CrV

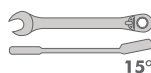

10 • 12 • 13 • 14 • 15  
15°

Part N°	€
457-015	175,25
450-011V *	15,30

\* Empty Plastic Holder

**5**

Pcs

CrV

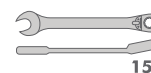

8 • 10 • 13 • 17 • 19  
15°

Part N°	€
457-014	180,52
450-011V *	15,30

\* Empty Plastic Holder

**457**

Plastic Holder

**6**

Pcs

CrV

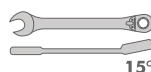

8 • 10 • 12 • 13 • 14 • 17  
15°

Part N°	€
457-016	205,02
450-011V *	15,30

\* Empty Plastic Holder

**7**

Pcs

CrV

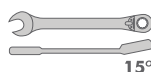

10 • 12 • 13 • 14 • 15 • 17 • 19  
15°

Part N°	€
457-017	257,65
455-012V *	14,62

\* Empty Plastic Holder

**8**

Pcs

CrV



8 • 10 • 11 • 12 • 13 • 14 • 17 • 19  
15°

Part N°	€
457-018	278,48
450-013V *	17,83

\* Empty Plastic Holder

**457**

Plastic Holder

**12**  
Pcs

CrV

72° 15°



8 • 9 • 10 • 11 • 12 • 13  
14 • 15 • 16 • 17 • 18 • 19  
15°

Part N°	€
457-020	422,15
450-017V *	24,21

\* Empty Plastic Holder

**457**

Carton Box

**5**  
Pcs

CrV

72° 15°



10 • 12 • 13 • 14 • 15  
15°

Part N°	€
457-035	175,25

**6**  
Pcs

CrV

72° 15°



10 • 12 • 13 • 14 • 15 • 17  
15°

Part N°	€
457-036	215,08

**457**

Carton Box

**6**  
Pcs

CrV

72° 15°



10 • 11 • 13 • 14 • 15 • 17  
15°

Part N°	€
457-046	214,01

**8**  
Pcs

CrV

72° 15°



8 • 10 • 12 • 13 • 14 • 15 • 17 • 19  
15°

Part N°	€
457-038	284,13

**457**

EVA Foam Tray

**7**  
Pcs

CrV

72° 15°



8 • 10 • 13 • 15 • 17 • 19 • 22  
15°

Part N°	€
457-081	268,33

**10**  
Pcs



10 • 12 • 13 • 14  
15° • 15 • 17 • 19 1/4" • 3/8" • 1/2"

Part N°	€
457-080	288,92 *

Further Information about Storage and EVA Foam Trays in Pages:

20 • 35

\* Until end of stock

# Gear Wrenches

## Non Reversible Combination Gear Wrenches



**4557**

### Non Reversible Combination Gear Wrench

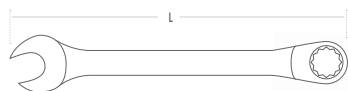

 mm	L mm	Part N°	€
<b>6</b>	130	<b>4557-06</b>	<b>20,36</b>
<b>7</b>	130	<b>4557-07</b>	<b>20,36</b>
<b>8</b>	140	<b>4557-08</b>	<b>15,90</b>
<b>9</b>	150	<b>4557-09</b>	<b>15,90</b>
<b>10</b>	160	<b>4557-10</b>	<b>17,44</b>
<b>11</b>	165	<b>4557-11</b>	<b>19,09</b>
<b>12</b>	172	<b>4557-12</b>	<b>20,16</b>
<b>13</b>	177	<b>4557-13</b>	<b>21,49</b>
<b>14</b>	191	<b>4557-14</b>	<b>22,42</b>
<b>15</b>	199	<b>4557-15</b>	<b>24,30</b>
<b>16</b>	209	<b>4557-16</b>	<b>26,16</b>
<b>17</b>	225	<b>4557-17</b>	<b>27,42</b>
<b>18</b>	237	<b>4557-18</b>	<b>29,84</b>
<b>19</b>	248	<b>4557-19</b>	<b>30,11</b>
<b>20</b>	248	<b>4557-20</b>	<b>34,97</b>
<b>21</b>	289	<b>4557-21</b>	<b>39,84</b>
<b>22</b>	289	<b>4557-22</b>	<b>42,98</b>
<b>24</b>	320	<b>4557-24</b>	<b>48,15</b>
<b>27</b>	364	<b>4557-27</b>	<b>57,69</b>
<b>30</b>	423	<b>4557-30</b>	<b>74,35</b>
<b>32</b>	423	<b>4557-32</b>	<b>76,48</b>

**4557**

Plastic Holders

**6**

Pcs

Cr-V



 • 8 • 10 • 11 • 12 • 13 • 17

Part N°	€
4557-016	129,75
450-011V *	15,30

\* Empty Plastic Holder

**4557**

Plastic Holders

**8**

Pcs

Cr-V



 • 8 • 10 • 11 • 12 • 13 • 14 • 17 • 19

Part N°	€
4557-018	182,28
450-013V *	17,83

\* Empty Plastic Holder

**4557**

Plastic Holders

**10**

Pcs

Cr-V



 • 8 • 9 • 10 • 11 • 12 • 13 • 14 • 15 • 16 • 17

Part N°	€
4557-020	218,53
450-015V *	22,93

\* Empty Plastic Holder

**4557**

Plastic Holders

**12**

Pcs

Cr-V



 • 8 • 9 • 10 • 11 • 12 • 13 • 14 • 15 • 16 • 17 • 18 • 19

Part N°	€
4557-022	278,48
450-017V *	24,21

\* Empty Plastic Holder

# Gear Wrenches

## Stubby Combination Gear Wrenches



459

### Stubby Combination Gear Wrench

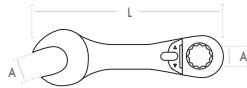

A mm	L mm	Part N°	€
8	93	459-08	19,06
10	95	459-10	21,46
13	106	459-13	23,67
17	125	459-17	28,79
19	138	459-19	31,50

## Stubby Combination Gear Wrench Sets

459

### Plastic Holder

5  
Pcs



• 8 • 10 • 13 • 17 • 19

Part N°	€
459-015	132,73
459-010V *	19,48

\* Empty Plastic Holder



**475**

4 in 1 Gear Wrench

CrV

72° 5°

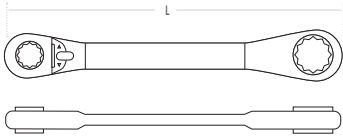

mm	mm	L mm	Part N°	€
8x10	12x13	165	475-08-13	31,01
9x11	14x15	180	475-09-15	36,27
10x13	17x19	204	475-10-19	41,04
13x15	17x19	225	475-13-19	38,48
16x17	18x19	225	475-16-19	41,04

4 in 1 Gear Wrench Sets

**475**

Nylon Pouch

**3**

Pcs

CrV

72° 5°



220 x 330 mm



- 8x10 12x13
- 9x11 14x15
- 16x17 18x19

Part N°	€
475-001	118,57
475-001 V *	14,50

\* Empty Nylon Pouch

# Gear Wrenches

Flexible Gear Wrenches



458

Flexible Gear Wrench

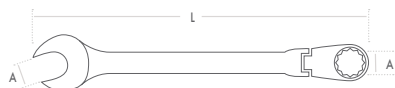

A mm	L mm	Part N°	€
6	136	458-06	24,47
7	136	458-07	24,65
8	136	458-08	24,62
9	150	458-09	26,08
10	158	458-10	27,16
11	175	458-11	28,58
12	175	458-12	30,88
13	185	458-13	31,32
14	193	458-14	33,15
15	215	458-15	34,83
16	215	458-16	35,23
17	231	458-17	37,61
18	249	458-18	38,61
19	249	458-19	41,27
20	280	458-20	47,96
21	280	458-21	48,71
22	280	458-22	53,69
24	310	458-24	61,23

**458**

Plastic Holder

**5**  
Pcs

Cr-V

72<sup>5ª</sup>



8 • 10 • 13 • 17 • 19

Part N°	€
458-015	170,23
450-011V *	15,30

\* Empty Plastic Holder

**458**

Plastic Holder

**8**  
Pcs

Cr-V

72<sup>5ª</sup>



8 • 10 • 11 • 12 • 13 • 14 • 17 • 19

Part N°	€
458-018	262,84
450-013V *	17,83

\* Empty Plastic Holder

**458**

Carton Box

**5**  
Pcs

Cr-V

72<sup>5ª</sup>



8 • 10 • 13 • 17 • 19

Part N°	€
458-035	170,23

**6**  
Pcs

Cr-V

72<sup>5ª</sup>



10 • 12 • 13 • 14 • 15 • 17

Part N°	€
458-036	203,20

**8**  
Pcs

Cr-V

72<sup>5ª</sup>



8 • 10 • 12 • 13 • 14 • 15 • 17 • 19

Part N°	€
458-038	269,09

# Gear Wrenches

## Double Box Flat Gear Wrench



456

### Double Box Flat Gear Wrench

CrV

72° 5°

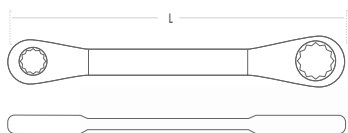

mm	mm	L mm	Part N°	€
6	7	115	456-06-07	22,19
7	8	115	456-07-08	22,19
8	9	130	456-08-09	22,19
10	11	145	456-10-11	24,60
12	13	166	456-12-13	31,09
13	17	181	456-13-17	31,27
14	15	181	456-14-15	32,31
16	18	205	456-16-18	34,95
17	19	225	456-17-19	35,92
20	22	255	456-20-22	58,91

## Double Box Flat Gear Wrench Sets

456

### Plastic Holder

5 Pcs

CrV

72° 5°



• 6x7 • 8x9 • 10x11 • 12x13 • 14x15

Part N°	€
456-015	140,63
450-011V *	15,30

\* Empty Plastic Holder

## Double Box Flat Gear Wrench Sets

**456**

Carton Box

**5**  
Pcs

Cr-V

72<sup>5º</sup>



• 8x9 • 10x11 • 12x13 • 14x15 • 16x18

Part N°	€
456-035	153,39

**456**

Carton Box

**6**  
Pcs

Cr-V

72<sup>5º</sup>



• 8x9 • 10x11 • 12x13 • 14x15 • 16x18 • 17x19

Part N°	€
456-036	189,31

## Double E Socket Gear Wrenches

**474**

Double E Socket Gear Wrench

Cr-V

72<sup>5º</sup>



		L mm	Part N°	€
<b>E6</b>	<b>E8</b>	130	474-E6-E8	27,59
<b>E10</b>	<b>E12</b>	144	474-E10-E12	28,86
<b>E14</b>	<b>E18</b>	180	474-E14-E18	35,67
<b>E20</b>	<b>E24</b>	220	474-E20-E24	42,75

# Gear Wrenches

## Double Box 15° Gear Wrenches



455

Double Box 15° Gear Wrench

CrV

72<sup>LS</sup>

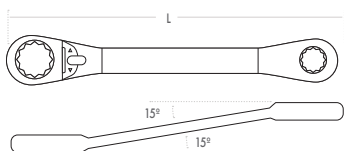

SAE

mm	mm	L mm	Part N°	€
6	7	115	455-06-07	36,08
8	9	130	455-08-09	36,08
8	10	130	455-08-10	36,08
10	11	145	455-10-11	38,20
10	12	145	455-10-12	38,20
10	13	145	455-10-13	40,93
12	13	166	455-12-13	42,17
12	14	166	455-12-14	42,17
14	15	180	455-14-15	42,64
14	17	180	455-14-17	46,91
16	17	205	455-16-17	46,91
16	18	205	455-16-18	46,91
17	19	225	455-17-19	48,80

		L mm	Part N°	€
1/4"	5/16"	115	455-1/4-5/16	34,39
3/8"	7/16"	145	455-3/8-7/16	36,93
1/2"	9/16"	166	455-1/2-9/16	41,01

455

Nylon Pouch

6

Pcs

CrV

72<sup>LS</sup>

300 x 390 mm

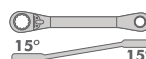

• 8x9 • 10x11 • 12x13 • 14x15 • 16x18 • 17x19

Part N°	€
455-001	261,05
455-001V *	19,44

\* Empty Nylon Pouch

455

Carton Box

5

Pcs

CrV

72<sup>LS</sup>



• 8x9 • 10x11 • 12x13 • 14x15 • 16x18

Part N°	€
455-035	214,25

455

Carton Box

6

Pcs

CrV

72<sup>LS</sup>

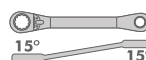

• 8x9 • 10x11 • 12x13 • 14x15 • 16x18 • 17x19

Part N°	€
455-036	263,05

### 455 Plastic Holder

**5**  
Pcs CrV 72<sup>15°</sup>

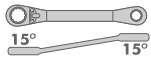

• 8x9 • 10x11 • 12x13 • 14x15 • 16x18

Part N°	€
455-015	214,25
450-011V *	15,30

\* Empty Plastic Holder

### 455 Plastic Holder

**7**  
Pcs CrV 72<sup>15°</sup>

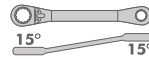

• 6x7 • 8x9 • 10x11 • 12x13 • 14x15 • 16x18 • 17x19

Part N°	€
455-017	299,13
455-012V *	14,62

\* Empty Plastic Holder

### 455 EVA Foam Tray

**9**  
Pcs

CrV

72<sup>15°</sup>

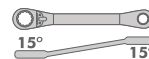

• 8x9 • 10x11 • 12x13 • 14x15 • 16x18 • 17x19



• 1/4" • 3/8" • 1/2"

1/3 (375 x 188 x 30 mm)

Part N°	€
455-080	294,32

Further Information about EVA Foam Trays

p. 20 • 35

## Accessories for Gear Wrenches

### 476 Square Drive

CrV



□	○ mm	Part N°	€
1/4"	10	476-1/4-10	7,92
3/8"	13	476-3/8-13	8,81
1/2"	19	476-1/2-19	10,29
3/4"	32	476-3/4-32	20,54

### 476 Bit Holder

CrV



○	○ mm	Part N°	€
1/4"	10	476-1/4P-10	2,98
5/16"	13	476-5/16P-13	4,98
10 mm	19	476-10P-19	6,05

# Wrenches

## Tubular Socket Wrenches



461

Double Ended Tubular Socket Wrench

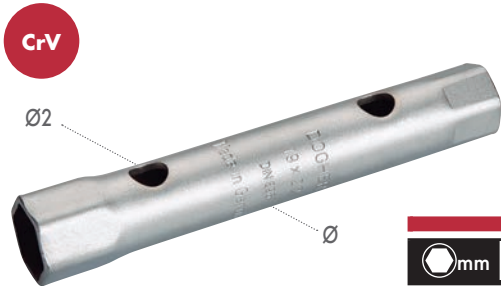

Bar

mm	mm	L mm	Ø mm	Ø2 mm	Part N°	€	L mm	Ø mm	Part N°	€
6	7	110	12	7	461-06-07	6,86				
8	9	110	14	7	461-08-09	7,56	131,5	6,5	460-04	5,32
8	10	120	13	6	461-08-10	8,19				
9	10	120	13	6	461-09-10	8,52	131,5	5,5	460-03	3,81
10	11	130	17	8	461-10-11	8,81				
10	13	140	15	8	461-10-13	9,10				
11	13	140	15	8	461-11-13	9,33				
12	13	140	17	8	461-12-13	9,51	131,5	7,5	460-05	6,69
12	14	143	17	8	461-12-14	9,92				
13	14	144	17	8	461-13-14	10,16				
13	15	142	17	8	461-13-15	10,27				
13	17	149	20	10	461-13-17	10,30	131,5	9,5	460-06	8,05
14	15	140	19	8	461-14-15	10,30	131,5	7,5	460-05	6,69
14	17	149	20	10	461-14-17	10,97	131,5	9,5	460-06	8,05
16	17	150	21	8	461-16-17	11,13	131,5	7,5	460-05	6,69
17	19	157	24	10	461-17-19	12,58	131,5	9,5	460-07	9,42
18	19	160	22	8	461-18-19	13,32	131,5	7,5	460-05	6,69
19	22	169	26	12	461-19-22	14,24	131,5	11,5	460-07	9,42
20	22	170	25,5	8	461-20-22	15,03				
21	23	170	25,5	8	461-21-23	16,85	131,5	7,5	460-05	6,69
22	24	184	33	14	461-22-24	17,80	131,5	12,5	460-08	11,84
24	26	190	32	8	461-24-26	18,22	131,5	7,5	460-05	6,69
24	27	183	30	14	461-24-27	19,69	131,5	12,5	460-08	11,84
25	28	190	32	8	461-25-28	21,11				
27	29	195	32	8	461-27-29	23,26	131,5	7,5	460-05	6,69
27	30	198	35	18	461-27-30	23,26	250	13,6	543-015	17,40
27	32	196	35	18	461-27-32	23,26	250	13,6	543-015	17,40
30	32	210	32	8	461-30-32	23,26	131,5	7,5	460-05	6,69
36	38	165	42,5	10	461-36-38	23,52	131,5	9,5	460-06	8,05
36	41	221	45	18	461-36-41	39,11				
41	46	237	50	18	461-41-46	45,53				
46	50	238	54	18	461-46-50	67,32				
50	55	238	60	18	461-50-55	80,18	500	18	460-10	26,36

• Additional Compatible Bars:

L mm	Ø mm	Part N°	€
115	7,5	509-015	8,31
200	11	524-015	12,83
250	13,6	543-015	17,40



**461**

Nylon Pouch

**8**

Pcs

Cr-V



380 x 400 mm



- 6x7
- 8x9
- 10x11
- 12x13
- 14x15
- 16x17
- 18x19
- 20x22

Part N°	€
<b>461-001</b>	<b>88,77</b>
<b>461-001V *</b>	<b>20,54</b>

\* Empty Nylon Pouch

**461**

Nylon Pouch

**12**

Pcs

Cr-V



520 x 390 mm



- 6x7
- 8x9
- 10x11
- 12x13
- 14x15
- 16x17
- 18x19
- 20x22
- 21x23
- 24x26
- 25x28
- 30x32

Part N°	€
<b>461-002</b>	<b>172,21</b>
<b>461-002V *</b>	<b>22,55</b>

\* Empty Nylon Pouch

# Wrenches

## Hex Socket Wrenches & Spare Bar



460

Double Ended Hex Socket Wrench

CrV



mm	mm	L mm	mm	Part N°	€
6	7	105	8	460-06-07	14,98
8	9	110	8,6	460-08-09	15,18
10	11	120	11	460-10-11	16,07
12	13	140	13	460-12-13	18,86
14	15	145	14	460-14-15	21,12
16	17	155	16	460-16-17	24,60
18	19	165	18	460-18-19	28,91
20	22	170	20	460-20-22	32,06
21	23	185	21	460-21-23	35,66
24	26	190	24	460-24-26	40,70
25	28	205	25	460-25-28	46,71
27	29	210	27	460-27-29	53,34
30	32	210	30	460-30-32	59,36

460

Double Ended Hex Socket Wrench Bar



Ø mm	mm	mm	Part N°	€
2,5	6	7	460-01	2,28
	8	9		
4,5	10	11	460-02	3,50
	12	13		
5,5	14	15	460-03	3,81
	16	17		
6,5	18	19	460-04	5,32
	20	22		
7,5	21	23	460-05	6,69
	24	26		
9,5	25	28	460-06	8,05
	27	29		
11,5	30	32	460-07	9,42
12,5			460-08	11,84

## Double Ended Hex Socket Wrench Sets

460

EVA Foam Tray

8  
Pcs

CrV



1/4 (375 x 140 x 30 mm)

- 6x7 • 8x9 • 10x11 • 12x13 • 14x15
- 16x17 • 18x19 • 20x22

Part N°	€
460-080	181,03

## Double Ended Hex Socket Wrench Sets

**460**

Nylon Pouch

**6**  
Pcs

Cr-V



330 x 350 mm



• 6x7 • 8x9 • 10x11 • 12x13 • 14x15 • 16x17

Part N°	€
460-001	117,06
460-001V *	18,19

\* Empty Nylon Pouch

**460**

Nylon Pouch

**8**  
Pcs

Cr-V



430 x 380 mm



• 6x7 • 8x9 • 10x11 • 12x13 • 14x15 • 16x17  
• 18x19 • 20x22

Part N°	€
460-002	178,03
460-002V *	19,97

\* Empty Nylon Pouch

**460**

Nylon Pouch

**10**  
Pcs

Cr-V



480 x 380 mm



• 6x7 • 8x9 • 10x11 • 12x13 • 14x15 • 16x17  
• 18x19 • 20x22 • 21x23 • 24x26

Part N°	€
460-003	256,39
460-003V *	19,97

\* Empty Nylon Pouch

**460**

Nylon Pouch

**12**  
Pcs

Cr-V



520 x 390 mm



• 6x7 • 8x9 • 10x11 • 12x13 • 14x15 • 16x17  
• 18x19 • 20x22 • 21x23 • 24x26 • 25x28 • 30x32

Part N°	€
460-004	363,46
460-004V *	21,95

\* Empty Nylon Pouch

# Wrenches

## Angled Wrenches



462

6x6 Angled Open Socket Wrench

CrV

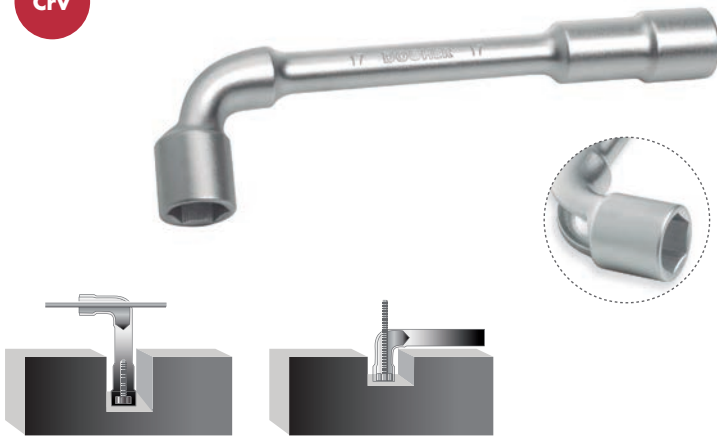

mm	L mm	Part N°	€
6	110	462-06	13,66
7	114	462-07	14,16
8	120	462-08	14,53
9	125	462-09	14,53
10	131	462-10	14,96
11	137	462-11	15,63
12	144	462-12	16,55
13	153	462-13	16,81
14	160	462-14	18,55
15	174	462-15	20,16
16	185	462-16	21,98
17	197	462-17	22,01
18	211	462-18	25,27
19	218	462-19	28,16
20	222	462-20	30,83
21	231	462-21	33,98
22	247	462-22	35,65
23	255	462-23	36,33
24	266	462-24	43,21
25	278	462-25	47,95
26	289	462-26	53,47
27	299	462-27	58,37
28	310	462-28	65,73
29	319	462-29	70,10
30	332	462-30	73,83
32	353	462-32	77,05

462

EVA Foam Tray

11  
Pcs

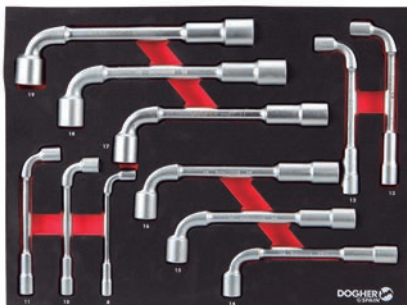

1/2 (375 x 280 x 30)



Part N°	€
462-080	234,61

Further Information about EVA Foam Trays

p. 20 • 35

**462**

6x6 Angled Open Socket Wrench Set

**5**  
Pcs

CrV



Part N°	€
462-010	93,11

**462**

6x6 Angled Open Socket Wrench Set

**10**  
Pcs

CrV



Part N°	€
462-011	183,27

**462**

Nylon Pouch

**6**  
Pcs

CrV



190 x 280 mm



Part N°	€
462-001	122,37
462-001V *	18,19

\* Empty Nylon Pouch

**462**

Nylon Pouch

**10**  
Pcs

CrV



Part N°	€
462-003	191,77
462-003V *	19,02

\* Empty Nylon Pouch

# Wrenches

## Angled Wrenches



467

Double Flexible Socket Wrench

CrV



mm	mm	L mm	Part N°	€
6	7	195	467-06-07	19,65
8	9	195	467-08-09	19,65
10	11	210	467-10-11	20,23
12	13	225	467-12-13	24,05
14	15	245	467-14-15	27,00
16	17	260	467-16-17	30,93
18	19	275	467-18-19	35,95
20	22	300	467-20-22	45,32
21	23	300	467-21-23	47,29
24	27	325	467-24-27	52,35

467

EVA Foam Tray

6 Pcs

CrV



1/3 (375 x 188 x 30 mm)

• 8x9 • 10x11 • 12x13 • 14x15 • 16x17 • 18x19

Part N°	€
467-080	170,31

Further Information about Storage and EVA Foam Trays in Pages: 20 • 35

465

"L" Type Handle

CrV

1/2"



mm	L mm	Part N°	€
1/2"	300	465-1/2-300	16,22

CrV

3/4"



mm	L mm	Part N°	€
3/4"	300	465-3/4-300	25,75
3/4"	450	465-3/4-450	34,37

467

Nylon Pouch

7 Pcs

CrV



330 x 390 mm

• 8x9 • 10x11 • 12x13 • 14x15 • 16x17  
• 18x19 • 20x22

Part N°	€
467-001	209,38
467-001V *	20,16

\* Empty Nylon Pouch

**466** 4 Way Lug Wrench

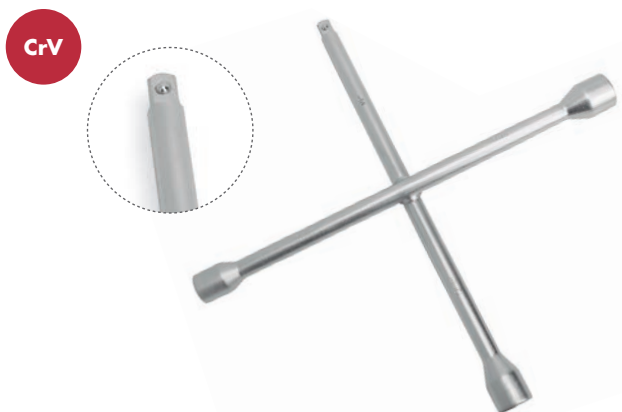

□	mm	L mm	Part N°	€
1/2"	17x19x22	375	466-1/2-375	31,23
3/4"	24x27x32	625	466-3/4-625	91,85

**468** "T" Type Spark Plug Flexible Socket Wrench



mm	L mm	Part N°	€
16	300	468-16-300	32,88
18	300	468-18-300	33,90
21	300	468-21-300	34,14

**469** "T" Type Universal Flexible Socket Wrench

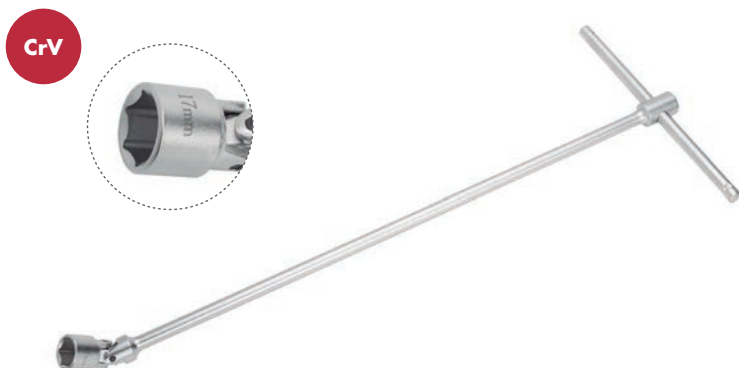

mm	L mm	Part N°	€
6	390	469-06-390	31,95
8	390	469-08-390	31,95
10	500	469-10-500	35,61
12	500	469-12-500	35,61
13	500	469-13-500	35,61
17	500	469-17-500	40,29
19	500	469-19-500	45,01







# Wrenches

## Universal Cabinet Keys



**470**

### Universal Control Cabinet Key Water, Gas

-  6-8 mm
-  PH2
-  7 mm
-  9 mm
-  9 mm
-  Adapt. 1/4"

Part N°	€
<b>470-001</b>	<b>23,37</b>



· Made of Zinc die casting. For technical installations in buildings, e.g., air conditioning and ventilation systems, shut-off valves, main switch-board, etc...

**EXP**

### 12 Universal Control Cabinet Keys: Water, Gas



**12**  
Pcs

**470-001 (x12)**

Part N°	€
<b>470-001J</b>	<b>280,44</b>

230 x 210 x 155 mm

**470**

### Universal Control Cabinet Key Boilers, AC

-  6-8 mm
-  PH2
-  Adapt. 1/4"
-  10 mm
-  9 mm
-  7 mm



Part N°	€
<b>470-002</b>	<b>23,79</b>

· Made of Zinc die casting. For technical installations in buildings, e.g., air conditioning and ventilation systems, shut-off valves, main switch-board, etc...



Hook Wrenches

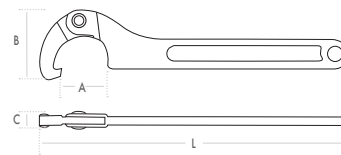

**471** Fixed Hook Wrench

CrV



 mm	L mm	Part N°	€
<b>13~35</b>	168	<b>471-13-35</b>	<b>37,28</b>
<b>35~50</b>	202	<b>471-35-50</b>	<b>40,59</b>
<b>50~80</b>	280	<b>471-50-80</b>	<b>55,70</b>
<b>80~120</b>	345	<b>471-80-120</b>	<b>72,17</b>
<b>120~180</b>	492	<b>471-120-180</b>	<b>99,27</b>

**472** Pin Hook Wrench

CrV



 mm	L mm	Part N°	€
<b>13~35</b>	168	<b>472-13-35</b>	<b>39,15</b>
<b>35~50</b>	202	<b>472-35-50</b>	<b>43,28</b>
<b>50~80</b>	280	<b>472-50-80</b>	<b>56,39</b>
<b>80~120</b>	345	<b>472-80-120</b>	<b>75,68</b>
<b>120~180</b>	492	<b>472-120-180</b>	<b>101,29</b>

**472** Spare Pin

CrV



 mm	Ø mm	Part N°	€
<b>13~35</b>	3	<b>472-0</b>	<b>3,35</b>
<b>35~50</b>	4	<b>472-1</b>	<b>4,42</b>
<b>50~80</b>	5	<b>472-2</b>	<b>6,22</b>
<b>80~120</b>	6	<b>472-3</b>	<b>7,92</b>
<b>120~180</b>	8	<b>472-4</b>	<b>10,36</b>

**471** Fixed Hook Wrench

CrV



 mm	L Handle	Part N°	€
<b>120~325</b>	600	<b>471-120-325</b>	<b>459,87</b>

**472** Adjustable Hook Wrenches Set



 mm	Part N°	€
<b>20~100</b>	<b>472-001</b>	<b>156,83</b>

# Wrenches

## Oil Drain Plug Key Wrenches



482

S-Type Oil Drain Plug Key Wrench

CrV

8 mm

10 mm

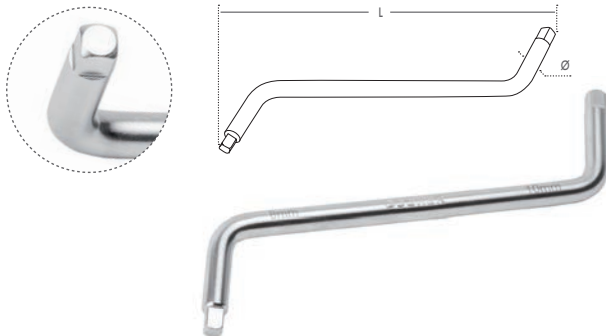

8 mm	10 mm	L mm	Ø mm	Part N°	€
8	10	255	12	482-001	12,31

• For oil crank and gear box plugs in Citroën, Peugeot, Renault, Volvo...

482

S-Type Heavy Duty Oil Drain Plug Key Wrench

CrV

8 mm

10 mm

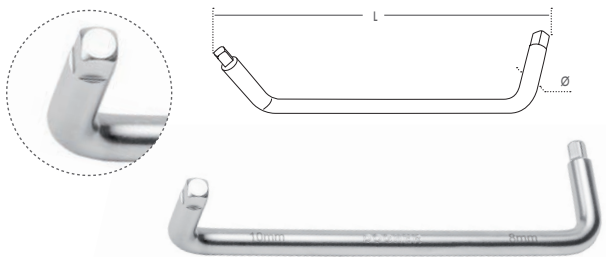

8 mm	10 mm	L mm	Ø mm	Part N°	€
8	10	235	13	482-002	19,75

• For oil crank and gear box plugs in Citroën, Peugeot, Renault, Volvo...

482

S-Type Heavy Duty Oil Drain Plug Key & Socket Wrench

CrV

8 mm

11 mm

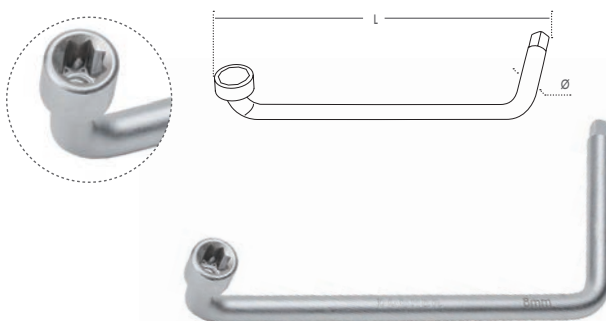

8 mm	11 mm	L mm	Ø mm	Part N°	€
8	11	250	12	482-003	22,55

• For oil crank and gear box plugs in Citroën, Peugeot, Renault, Volvo...

480

Tyre Lever Wrench



L mm	Part N°	€
215	480-215	8,61
350	480-350	14,88
380	480-380	22,51
500	480-500	25,46

## Tyre Lever and Oil Filter Wrenches

### 466 Tyre Lever Wrench



mm	Part N°	€
17	466-17	16,13
19	466-19	17,18
21	466-21	19,12
23	466-23	20,50

### 481 Adjustable 3 position Oil Filter Wrench



mm	Part N°	€
85~115	481-85-115	31,16

### 481 Oil Filter Belt Wrenches



mm	Part N°	€
65~105	481-65-105	26,66
110~165	481-110-165	28,32

• Remove the screw at the rotary rear end to replace the band.

### 481 Spare Belt



mm	Part N°	€
65~105	481-65-105R	7,89
110~165	481-110-165R	8,83

Suitable for  
481-65-105 / 481-110-165

### 480 Trim Removal Tools Set

11  
Pcs



- Tools to facilitate the dismantling of panels, dashboards, mouldings, boards and other accessories from the vehicle interior.
- Manufactured in high resistance plastic to guarantee a long durability.
- Avoid possible damages in the softer surfaces and pieces.



Part N°	€
480-011	42,26

# Wrenches

## Oil Filter Wrenches



**481**

Chain Oil Filter Wrench



L mm (Chain)	Ø mm	Part N°	€
<b>350</b>	60-105	<b>481-010</b>	<b>56,95</b>
<b>520</b>	60-160	<b>481-011</b>	<b>84,71</b>

Chain Spare

<b>481-010R</b>	<b>39,57</b>
<b>481-011R</b>	<b>47,51</b>

**481**

Belt Oil Filter Wrench



L mm (Belt)	Ø mm	Part N°	€
<b>580</b>	60-140	<b>481-020</b>	<b>36,30</b>
<b>840</b>	60-265	<b>481-021</b>	<b>67,29</b>

Spare Belt

<b>481-020R</b>	<b>17,96</b>
<b>481-021R</b>	<b>22,54</b>

**481**

Oil Filter Cap Set

**30**  
Pcs



Part N°	€
<b>481-001</b>	<b>211,74</b>

Includes:

- 28 press-on sleeve
- 3 Claw Adjustable Oil Filter Wrench 65-120mm
- 1 Reduction adaptor 1/2" to 3/8"

**481** Oil Filter Cap

CrV

DIN7444



	Ø mm	Part N°	€	
<b>14</b>	65	<b>481-101</b>	<b>15,39</b>	Daihatsu - Toyota - Nissan - Fiat
<b>6</b>	66	<b>481-102</b>	<b>15,39</b>	Fiat Punto 1.2 - Renault Clio 1.2 - Rapid - Twingo
<b>14</b>	65-67	<b>481-103</b>	<b>15,39</b>	Daihatsu - Toyota - Nissan - Fiat
<b>14</b>	68	<b>481-104</b>	<b>15,39</b>	Mazda - Ford - Subaru
<b>14</b>	73	<b>481-105</b>	<b>15,39</b>	Toyota - Lexus - Alfa Romeo
<b>15</b>	74	<b>481-106</b>	<b>15,39</b>	Audi - General Motors - Rover - Chrysler
<b>15</b>	74-76	<b>481-107</b>	<b>15,39</b>	Ford - Opel - VW, Audi - Mercedes-Benz - Chrysler
<b>15</b>	75-77	<b>481-108</b>	<b>15,39</b>	VW - Audi - Isuzu - Mercedes-Benz - Ford - Opel
<b>8</b>	76	<b>481-109</b>	<b>15,39</b>	Fiat Marea - Lancia Delta
<b>12</b>	76	<b>481-110</b>	<b>15,39</b>	Fiat - Mercedes-Benz - Renault
<b>14</b>	76	<b>481-111</b>	<b>15,39</b>	VW - Porsche - Mercedes-Benz - BMW, Audi - Opel
<b>30</b>	76	<b>481-112</b>	<b>15,39</b>	Ford - Motorcraft FL400A
<b>15</b>	78	<b>481-113</b>	<b>15,39</b>	Nissan - Ford - Toyota - Honda
<b>15</b>	80	<b>481-114</b>	<b>15,39</b>	Nissan - Honda - Opel - Mazda - Subaru - Toyota
<b>15</b>	80-82	<b>481-115</b>	<b>15,39</b>	Subaru - Toyota - Honda - Nissan - Mazda - Acura
<b>16</b>	86	<b>481-116</b>	<b>15,39</b>	Volvo
<b>18</b>	86	<b>481-117</b>	<b>15,39</b>	VW - Audi - Peugeot - Citroen - Renault
<b>18</b>	90	<b>481-118</b>	<b>15,39</b>	Honda - Mitsubishi - Isuzu - Subaru - Mazda
<b>10</b>	92	<b>481-119</b>	<b>15,39</b>	Fiat - Lancia
<b>15</b>	93	<b>481-120</b>	<b>15,39</b>	Mazda - Volvo - Mitsubishi - Nissan - Honda
<b>36</b>	93	<b>481-121</b>	<b>15,39</b>	Ford - Motorcraft FLINFLA 1B - FL3001 - FL320
<b>45</b>	93	<b>481-122</b>	<b>15,39</b>	VW - Audi
<b>15</b>	95	<b>481-123</b>	<b>15,39</b>	Toyota - Alfa Romeo - Ford - General Motors - Chrysler
<b>18</b>	96	<b>481-124</b>	<b>15,39</b>	Audi - VW - Renault
<b>15</b>	100	<b>481-125</b>	<b>15,39</b>	Isuzu - Mitsubishi
<b>15</b>	106	<b>481-126</b>	<b>15,39</b>	Fiat - Scania - MAN
<b>15</b>	108	<b>481-127</b>	<b>15,39</b>	Volvo Diesel C70 - S70 - N70 - 850 TDI
<b>18</b>	108	<b>481-128</b>	<b>15,39</b>	Daihatsu - Toyota - Nissan - Fiat

**905** 3 Claw Adjustable Oil Filter Wrench

3/8"



Ø mm	Part N°	€
<b>65-120</b>	<b>905-020</b>	<b>20,33</b>

# Wrenches

Impact Ring Spanner



452

Slogging Ring Wrench

CrV

DIN7444



mm	L mm	Part N°	€
17	146	452-17	30,96
19	147	452-19	31,10
22	152	452-22	31,74
24	163	452-24	32,35
27	180	452-27	35,77
30	190	452-30	42,41
32	190	452-32	45,58
36	205	452-36	52,66
41	230	452-41	71,57
46	240	452-46	78,08
50	253	452-50	91,78
55	266	452-55	104,97
60	280	452-60	110,67
65	300	452-65	148,28
70	330	452-70	171,48
75	330	452-75	184,15
80	360	452-80	244,98
85	360	452-85	328,05
90	390	452-90	422,12
95	390	452-95	451,22
100	420	452-100	517,74
105	420	452-105	606,25
110	450	452-110	665,24
115	450	452-115	746,73
120	480	452-120	918,40
125	480	452-125	1.221,41
130	520	452-130	1.328,39
135	520	452-135	1.370,24
140	520	452-140	1.639,44
145	580	452-145	2.157,56
150	580	452-150	2.271,24
155	580	452-155	2.466,02
160	650	452-160	2.613,29
165	650	452-165	2.776,10
170	650	452-170	2.786,05
175	650	452-175	2.988,58
180	650	452-180	3.207,75

**478**

Open Ended Slogging Wrench

**DIN133**
**CrV**

mm	L mm	Part N°	€
<b>22</b>	133	<b>478-22</b>	<b>31,22</b>
<b>24</b>	177	<b>478-24</b>	<b>31,67</b>
<b>27</b>	180	<b>478-27</b>	<b>32,79</b>
<b>30</b>	190	<b>478-30</b>	<b>38,48</b>
<b>32</b>	190	<b>478-32</b>	<b>40,85</b>
<b>36</b>	215	<b>478-36</b>	<b>52,58</b>
<b>41</b>	235	<b>478-41</b>	<b>64,49</b>
<b>46</b>	255	<b>478-46</b>	<b>86,84</b>
<b>50</b>	275	<b>478-50</b>	<b>98,93</b>
<b>55</b>	300	<b>478-55</b>	<b>115,43</b>
<b>60</b>	320	<b>478-60</b>	<b>128,26</b>
<b>65</b>	342	<b>478-65</b>	<b>160,69</b>
<b>70</b>	375	<b>478-70</b>	<b>207,03</b>
<b>75</b>	375	<b>478-75</b>	<b>221,71</b>
<b>80</b>	408	<b>478-80</b>	<b>289,50</b>
<b>85</b>	408	<b>478-85</b>	<b>304,15</b>
<b>90</b>	445	<b>478-90</b>	<b>388,42</b>
<b>95</b>	445	<b>478-95</b>	<b>408,60</b>
<b>100</b>	485	<b>478-100</b>	<b>626,62</b>
<b>105</b>	485	<b>478-105</b>	<b>699,93</b>
<b>110</b>	510	<b>478-110</b>	<b>764,05</b>
<b>115</b>	510	<b>478-115</b>	<b>894,14</b>
<b>120</b>	545	<b>478-120</b>	<b>908,82</b>
<b>125</b>	545	<b>478-125</b>	<b>1.002,92</b>

**479**

Single Open Ended Wrench

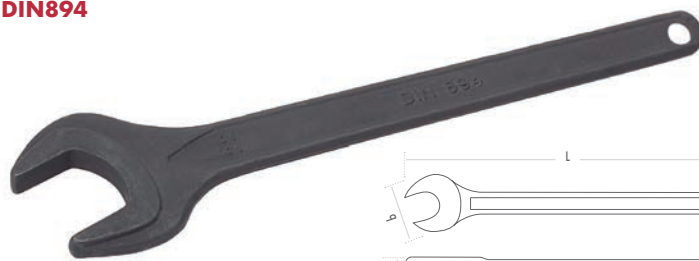
**DIN894**

mm	L mm	a mm	b mm	Part N°	€
<b>07</b>	78	3,2	15	<b>479-07</b>	<b>3,79</b>
<b>08</b>	94	3,7	18	<b>479-08</b>	<b>3,79</b>
<b>09</b>	100	3,7	20	<b>479-09</b>	<b>3,80</b>
<b>10</b>	106	4,5	22	<b>479-10</b>	<b>3,80</b>
<b>11</b>	112	4,8	24	<b>479-11</b>	<b>3,91</b>
<b>12</b>	125	4,3	26	<b>479-12</b>	<b>3,91</b>
<b>13</b>	125	5,1	27	<b>479-13</b>	<b>3,91</b>
<b>14</b>	135	5,3	30	<b>479-14</b>	<b>4,55</b>
<b>15</b>	140	5,5	32	<b>479-15</b>	<b>4,73</b>
<b>16</b>	156	5,3	33	<b>479-16</b>	<b>4,88</b>
<b>17</b>	158	5,8	35	<b>479-17</b>	<b>4,89</b>
<b>18</b>	171	5,4	37	<b>479-18</b>	<b>4,89</b>
<b>19</b>	171	6,5	39	<b>479-19</b>	<b>5,10</b>
<b>22</b>	190	6,9	44	<b>479-22</b>	<b>6,36</b>
<b>24</b>	208	8,3	49	<b>479-24</b>	<b>7,67</b>
<b>27</b>	235	8,9	55	<b>479-27</b>	<b>8,77</b>
<b>30</b>	262	9,6	61	<b>479-30</b>	<b>10,30</b>
<b>32</b>	274	10,2	64	<b>479-32</b>	<b>11,64</b>
<b>34</b>	284	10,1	69	<b>479-34</b>	<b>19,33</b>
<b>36</b>	295	11,3	72	<b>479-36</b>	<b>20,93</b>
<b>38</b>	295	11,6	77	<b>479-38</b>	<b>23,57</b>
<b>41</b>	335	12,3	83	<b>479-41</b>	<b>24,00</b>
<b>46</b>	370	12,6	91	<b>479-46</b>	<b>27,15</b>
<b>50</b>	400	13,5	100	<b>479-50</b>	<b>34,01</b>
<b>55</b>	445	15,8	113	<b>479-55</b>	<b>40,17</b>
<b>60</b>	475	16,0	121	<b>479-60</b>	<b>56,63</b>
<b>65</b>	510	17,2	132	<b>479-65</b>	<b>67,92</b>
<b>70</b>	560	19,8	142	<b>479-70</b>	<b>79,33</b>
<b>75</b>	585	19,6	152	<b>479-75</b>	<b>136,65</b>
<b>80</b>	635	22,1	160	<b>479-80</b>	<b>161,28</b>
<b>85</b>	675	23,4	175	<b>479-85</b>	<b>196,89</b>
<b>90</b>	745	22,1	190	<b>479-90</b>	<b>220,20</b>
<b>95</b>	855	26,7	205	<b>479-95</b>	<b>334,99</b>
<b>100</b>	1000	26,1	205	<b>479-100</b>	<b>341,46</b>

# Wrenches

Single Ended Ring Spanner



484

Deep Offset Slogging Ring Wrench

CrV



mm	Part N°	€
24	484-24	64,30
27	484-27	64,30
30	484-30	64,30
32	484-32	68,27
36	484-36	78,03
38	484-38	93,93
41	484-41	95,94
43	484-43	103,06
46	484-46	106,95
50	484-50	128,80
55	484-55	144,15
60	484-60	177,95
65	484-65	200,51
70	484-70	218,58
75	484-75	238,44
80	484-80	261,94
85	484-85	281,82
90	484-90	560,02
95	484-95	606,97
100	484-100	641,24
105	484-105	675,51
110	484-110	889,13
115	484-115	958,32

484

Deep Offset Slogging Ring Wrench Set

CrV



L mm	Ø mm	g	Part N°	€
350	32	960	484-001	58,05
580	32	1.600	484-002	78,18
850	32	2.300	484-003	122,99



# Wrenches

## Insulated Wrenches

VDE insulated Wrenches tested at 10.000V and certified for 1.000V

**4581**

### Insulated Open Wrench



A mm	L mm	a mm	b mm	Part N°	€
6	89	7	22	4581-06	23,08
7	89	7	24	4581-07	23,17
8	99	7	25	4581-08	24,65
9	99	7	28	4581-09	24,76
10	108	8	29	4581-10	24,90
11	108	8	31	4581-11	25,35
12	129	8	33	4581-12	26,59
13	134	10	34	4581-13	26,59
14	144	10	37	4581-14	27,96
15	148	11	40	4581-15	27,95
16	158	11	42	4581-16	29,06
17	158	12	44	4581-17	29,61
18	173	12	44	4581-18	30,29
19	173	12	47	4581-19	31,45
21	194	12	50	4581-21	35,55
22	194	13	54	4581-22	39,41
24	224	13	56	4581-24	45,63
27	250	14	61	4581-27	48,73
30	287	14	66	4581-30	54,33
32	307	16	70	4581-32	55,66

**4583**

### Insulated Ring Wrench

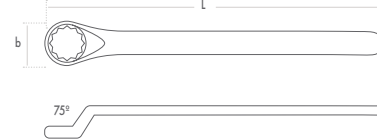

⌀	L mm	b mm	Part N°	€
6	151	16	4583-06	32,75
7	153	17	4583-07	32,75
8	157	18	4583-08	34,51
9	157	20	4583-09	35,18
10	172	21	4583-10	35,07
11	173	23	4583-11	35,39
12	194	23	4583-12	35,39
13	194	26	4583-13	37,96
14	207	26	4583-14	39,04
15	207	27	4583-15	40,47
16	218	30	4583-16	41,04
17	220	31	4583-17	42,29
18	234	32	4583-18	43,03
19	234	34	4583-19	44,48
21	248	38	4583-21	46,82
22	250	38	4583-22	47,17
24	270	40	4583-24	47,17

**4581**

### Nylon Pouch

**14**

Pcs

CrV



650 x 440 mm



8 • 9 • 10 • 11 • 12 • 13 • 14  
17 • 19 • 22 • 24 • 27 • 30 • 32

Part N°	€
4581-002	485,62
451-002V *	23,02

\* Empty Nylon Pouch

# Adjustable Wrenches

## Insulated Wrenches



**495**

Insulated Adjustable Wrench

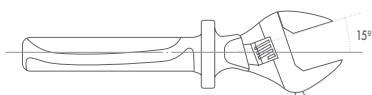

L mm	L "	mm	Part N°	€
<b>200</b>	<b>8</b>	25	<b>495-200</b>	<b>49,99</b>
<b>250</b>	<b>10</b>	33	<b>495-250</b>	<b>59,12</b>

Bimaterial Handle

**497**

Insulated Spanish Type Adjustable Wrench

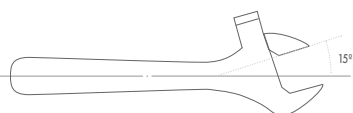

L mm	L "	mm	Part N°	€
<b>200</b>	<b>8</b>	28	<b>497-200</b>	<b>179,97</b>
<b>250</b>	<b>10</b>	33	<b>497-250</b>	<b>201,23</b>
<b>300</b>	<b>12</b>	38	<b>497-300</b>	<b>219,23</b>