









Herramienta Variada

		392
		393
		
		394
		395
		396
		
		396





Herramienta Variada

Tronzatuercas



901

Tronzatuercas Profesional



mm	Part N°	€
3 ~ 12 mm	901-03-12	33,08
12 ~ 16 mm	901-12-16	38,63
16 ~ 22 mm	901-16-22	47,75

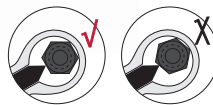

• Retira tuercas atascadas sin dañar la rosca.

• Coloque el tronzatuercas como se indica en el dibujo para un correcto uso de la herramienta.

902

Extractor Reversible de 2 Patas

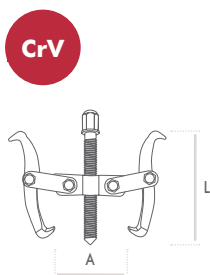

L mm	L"	A min-A max	Rosca	Part N°	€
75	3"	15-80	Tr 12x2	902-075	34,68
100	4"	20-110	Tr 14x2,5	902-100	40,83
150	6"	25-160	Tr 17x2,5	902-150	54,70
200	8"	30-210	Tr 21x2,5	902-200	99,73
300	12"	50-310	Tr 30x4	902-300	214,95

903

Extractor Reversible de 3 Patas

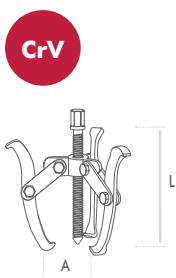

L mm	L"	A min-A max	Rosca	Part N°	€
75	3"	15-80	Tr 12x2	903-075	41,61
100	4"	20-110	Tr 14x2,5	903-100	48,99
150	6"	25-160	Tr 17x2,5	903-150	65,64
200	8"	30-210	Tr 21x2,5	903-200	119,67
300	12"	50-310	Tr 30x4	903-300	314,95

904

Extractor Universal Reversible de 2 Garras

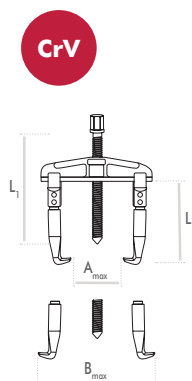

A min-A max	B min-Bmax	L	Rosca	L ₁	Part N°	€
30-90	70-130	100	M14x1,5	130	904-90-100	59,00
35-130	80-180	100	M14x1,5	130	904-130-100	60,00
40-160	105-220	150	M20x2	210	904-160-150	99,50
40-200	120-270	150	M20x2	210	904-200-150	137,00
60-250	160-330	205	M27x2	280	904-250-200	250,00
60-350	160-420	205	M27x2	280	904-350-200	273,12
90-520	195-600	205	M27x2	280	904-520-200	468,05



Herramienta Variada

Pistolas Selladoras



910

Pistola Selladora Cuerpo de Acero

Ø mm
50



L mm	Ø mm	Part N°	€
225	50	910-225	4,98
250	50	910-250	8,87

911

Pistola Selladora Mango de Zinc

Ø mm
50



L mm	Ø mm	Part N°	€
225	50	911-225	8,25

912

Pistola Selladora Mango de Aluminio

Ø mm
50



L mm	Ø mm	Part N°	€
225	50	912-225	17,55
250	50	912-250	18,08

• Reducción de Esfuerzo del 50%

913

Aplicador de Mortero Cuerpo de Aluminio

Ø mm
50



L mm	Ø mm	Part N°	€
225	50	913-225	17,00
300	50	913-300	17,75
375	50	913-375	20,25

Accesorios para Aplicador de Mortero

913

Boquillas de Repuesto para Aplicador de Mortero

2
Pcs

Apta para
913



Part N°	€/ 2Pcs
913-001	1,57



Herramienta Variada

Tornillos de Banco Profesionales



925

Tornillo de Banco de Guía Redonda

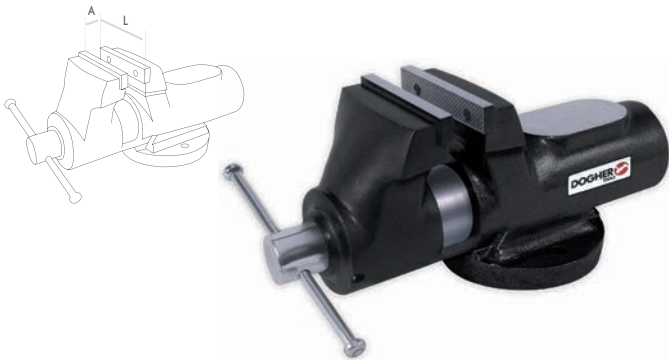

L mm	A mm	Kg	Part N°	€
100	105	13	925-100	282,45
125	130	22	925-125	388,90
150	155	32	925-150	555,30

926

Tornillo de Banco de Guía Cuadrada

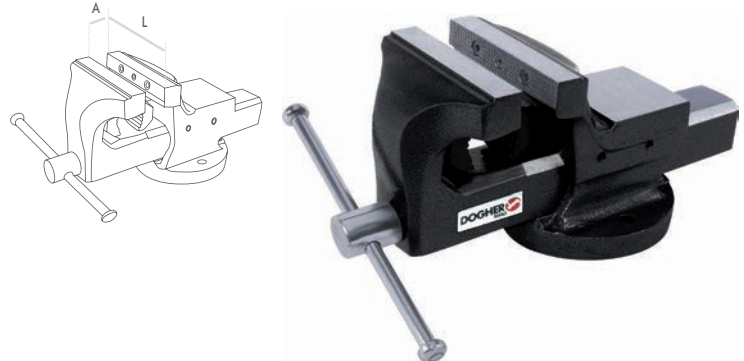

L mm	A mm	Kg	Part N°	€
100	105	7,5	926-100	172,45
125	130	12	926-125	192,18
150	155	17	926-150	277,45
175	175	26	926-175	439,40

• Incluye Mordaza para Tubo

925R

Mordazas de Repuesto

Apta para
925

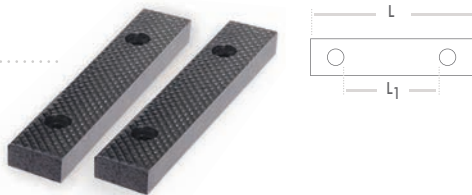

L mm	L ₁ mm	Part N°	€/ 2Pcs
100	53	925R-100	23,09
125	73	925R-125	34,16
150	88	925R-150	41,80

926R

Mordazas de Repuesto

Apta para
926

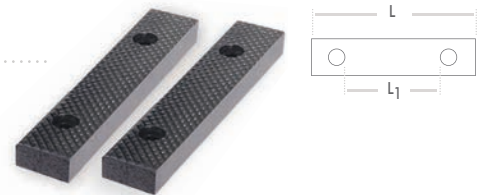

L mm	L ₁ mm	Part N°	€/ 2Pcs
100	24	926R-100	27,80
125	28	926R-125	32,80
150	43	926R-150	37,45
175	53	926R-175	41,93

926B

Base Giratoria

Apta para
926



L mm	Part N°	€
100	926B-100	27,45
125	926B-125	29,43
150	926B-150	37,80
175	926B-175	59,68